

Digital Video Camera Recorder ^{Mini DV} Digital Video Cassette

Operating Instructions

Before operating the unit, please read this manual thoroughly, and retain it for future reference.

Owner's Record

The model and serial numbers are located on the bottom. Record the serial number in the space provided below. Refer to these numbers whenever you call upon your Sony dealer regarding this product.

Model No. **DCR-PC** _____ Model No. **AC**-_____

Serial No. _____ Serial No. _____

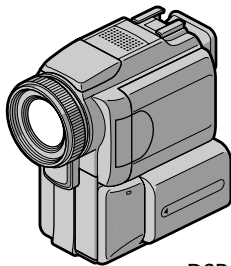

DCR-PC120BT

Digital Handycam
Network Handycam



DCR-PC115/PC120BT

Welcome!

Congratulations on your purchase of this Sony Handycam. With your Handycam, you can capture life's precious moments with superior picture and sound quality. Your Handycam is loaded with advanced features, but at the same time it is very easy to use. You will soon be producing home video that you can enjoy for years to come.

WARNING

To prevent fire or shock hazard, do not expose the unit to rain or moisture.

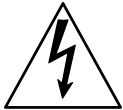
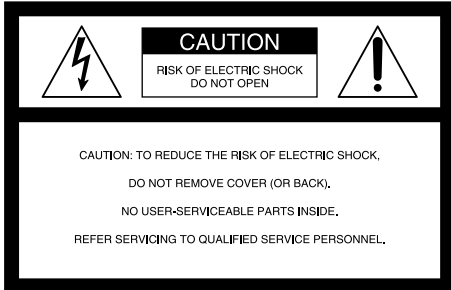

This symbol is intended to alert the user to the presence of uninsulated "dangerous voltage" within the product's enclosure that may be of sufficient magnitude to constitute a risk of electric shock to persons.



This symbol is intended to alert the user to the presence of important operating and maintenance (servicing) instructions in the literature accompanying the appliance.

CAUTION

The use of optical instruments with this product will increase eye hazard. As the laser beam used in this Handycam is harmful to eyes, do not attempt to disassemble the cabinet.

Refer to servicing to qualified personnel only.

For customers in the U.S.A. and CANADA

CAUTION

TO PREVENT ELECTRIC SHOCK, MATCH WIDE BLADE OF PLUG TO WIDE SLOT, FULLY INSERT.

DISPOSAL OF LITHIUM ION BATTERY. LITHIUM ION BATTERY. DISPOSE OF PROPERLY.

You can return your unwanted lithium ion batteries to your nearest Sony Service Center or Factory Service Center.

Note: In some areas the disposal of lithium ion batteries in household or business trash may be prohibited.

For the Sony Service Center nearest you call 1-800-222-SONY (United States only).

For the Sony Factory Service Center nearest you call 416-499-SONY (Canada only).

Caution: Do not handle damaged or leaking lithium ion battery.

"Memory Stick"

THIS DEVICE COMPLIES WITH PART 15 OF THE FCC RULES. OPERATION IS SUBJECT TO THE FOLLOWING TWO CONDITIONS:

(1) THIS DEVICE MAY NOT CAUSE HARMFUL INTERFERENCE, AND (2) THIS DEVICE MUST ACCEPT ANY INTERFERENCE RECEIVED, INCLUDING INTERFERENCE THAT MAY CAUSE UNDESIRE OPERAION.

THIS CLASS B DIGITAL APPARATUS COMPLIES WITH CANADIAN ICES-003.

DCR-PC120BT only

Countries and areas where you can use network functions are restricted.

For details, refer to the separate Network Operating Instructions.

For customers in the U.S.A.

If you have any questions about this product, you may call:
Sony Customer Information Center 1-800-222-SONY (7669)
The number below is for the FCC related matters only.

Regulatory Information

Declaration of Conformity

Trade Name: SONY
Model No.: DCR-PC120
Responsible Party: Sony Electronics Inc.
Address: 680 Kinderkamack
Road, Oradell,
NJ07649 U.S.A.
Telephone No.: 201-930-6972

This device complies with Part 15 of the FCC Rules. Operation is subject to the following two conditions: (1) This device may not cause harmful interference, and (2) this device must accept any interference received, including interference that may cause undesired operation.

CAUTION

You are cautioned that any changes or modifications not expressly approved in this manual could void your authority to operate this equipment.

Note:

This equipment has been tested and found to comply with the limits for a Class B digital device, pursuant to Part 15 of the FCC Rules. These limits are designed to provide reasonable protection against harmful interference in a residential installation. This equipment generates, uses, and can radiate radio frequency energy and, if not installed and used in accordance with the instructions, may cause harmful interference to radio communications. However, there is no guarantee that interference will not occur in a particular installation. If this equipment does cause harmful interference to radio or television reception, which can be determined by turning the equipment off and on, the user is encouraged to try to correct the interference by one or more of the following measures:

- Reorient or relocate the receiving antenna.
- Increase the separation between the equipment and receiver.
- Connect the equipment into an outlet on a circuit different from that to which the receiver is connected.
- Consult the dealer or an experienced radio/TV technician for help.

The supplied interface cable must be used with the equipment in order to comply with the limits for a digital device pursuant to Subpart B of Part 15 of FCC Rules.

Main Features

Taking moving or still images, and playing them back

- Recording a moving picture on a tape (p. 20)
- Recording a still image on a tape (p. 36)
- Playing back a tape (p. 31)
- Recording still images on “Memory Stick”s (p. 112)
- Recording moving pictures on “Memory Stick”s (p. 126)
- Viewing a still image recorded on “Memory Stick”s (p. 136)
- Viewing a moving picture on “Memory Stick”s (p. 139)

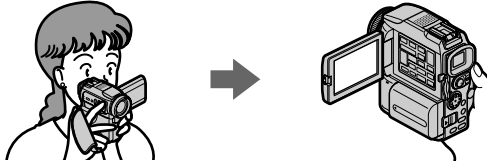

Capturing images on your computer

- Using with an analog video unit and your computer (p. 80)
- Viewing images recorded on “Memory Stick”s using the USB cable (p. 141)

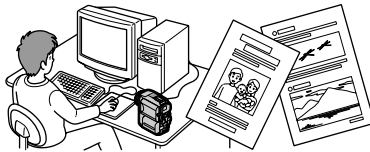

Accessing the Internet via a Bluetooth equipped device (DCR-PC120BT only)

Accessing the Internet, sending/receiving your e-mail. For details, refer to the Network Function Operating Instructions supplied with your camcorder. (p. 155)

Other uses

Functions to adjust exposure in the recording mode

- Back light (p. 27)
- NightShot/Super NightShot (p. 27)
- Recording images with the flash (p. 37, 115)
- PROGRAM AE (p. 49)
- Adjusting the exposure manually (p. 52)

Functions to give images more impact

- Digital zoom (p. 24) The default setting is set to OFF. (To zoom greater than 10×, select the digital zoom power in D ZOOM in the menu settings.)
- Fader (p. 42)
- Picture effect (p. 45)
- Digital effect (p. 46)
- Title (p. 90)
- MEMORY MIX (p. 121)

Functions to give a natural appearance to your recordings

- Manual focus (p. 53)
- Sports lesson (p. 49)
- Landscape (p. 49)

Functions to use on recorded tapes

- END SEARCH/EDITSEARCH/Rec Review (p. 30)
- DATA CODE (p. 32)
- Tape PB ZOOM (p. 60)
- Zero set memory (p. 61)
- Title search (p. 62)
- Digital program editing (p. 69, 132)
- HiFi SOUND (p. 166)

Checking supplied accessories

Make sure that the following accessories are supplied with your camcorder.

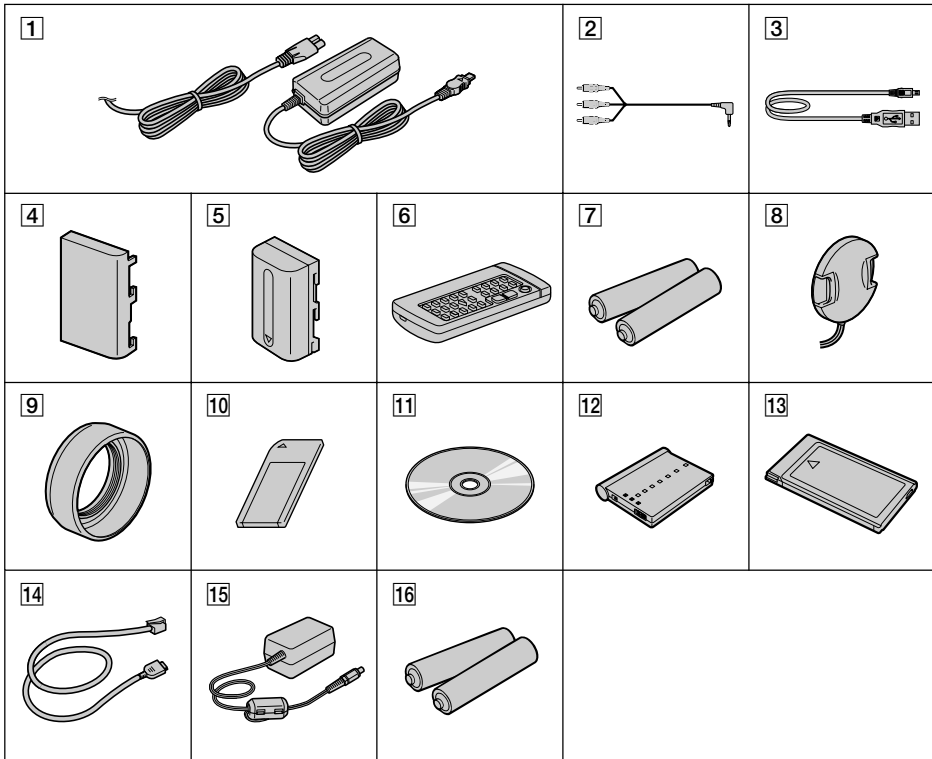

- 1 AC-L10A/L10B/L10C AC power adaptor (1), Power cord (1) (p. 13)
- 2 A/V connecting cable (1) (p. 35)
- 3 USB cable (1) (p. 142)
- 4 Battery terminal cover (1) (p. 12)
- 5 NP-FM50 battery pack (1) (p. 12, 13)
- 6 Wireless Remote Commander (1) (p. 185)
- 7 Size AA (R6) battery for Remote Commander (2) (p. 185)
- 8 Lens cap (1) (p. 20)
- 9 Lens hood (1) (p. 23)

- 10 "Memory Stick" (1) (p. 104)
- 11 CD-ROM (SPVD-004 USB Driver) (1) (p. 142)
- 12 Modem Adaptor with Bluetooth Function (BTA-NW1) * (1) (p. 155)
- 13 Bluetooth modem card (MDM-5614G)*(1)
- 14 Bluetooth modem cable*(1)
- 15 AC power adaptor (AC-PT1)*(1)
- 16 Size AA alkaline dry batteries for Modem Adaptor with Bluetooth Function*(2)

* DCR-PC120BT only. For details, refer to the operating instructions of the Modem Adaptor with Bluetooth Function.

Contents of the recording cannot be compensated if recording or playback is not made due to a malfunction of the camcorder, storage media, etc.

Table of contents

Main Features	4
Checking supplied accessories	5

Quick Start Guide

Getting started

Using this manual	10
Step 1 Preparing the power supply ...	12
Installing the battery pack	12
Charging the battery pack	13
Connecting to a wall outlet	15
Step 2 Setting the date and time	16
Step 3 Inserting a cassette	19

Recording - Basics

Recording a picture	20
Shooting backlit subjects	
- BACK LIGHT	27
Shooting in the dark - NightShot/ Super NightShot	27
Self-timer recording	29
Checking the recording	
- END SEARCH / EDITSEARCH / Rec Review	30

Playback - Basics

Playing back a tape	31
To display the screen indicators	
- Display function	32
Viewing the recording on TV	35

Advanced Recording Operations

Recording a still image on a tape	
- Tape Photo recording	36
Adjusting the white balance	
manually	40
Using the wide mode	41
Using the fader function	42
Using special effects - Picture effect ..	45
Using special effects - Digital effect ...	46
Using the PROGRAM AE function	49
Adjusting the exposure manually	52
Focusing manually	53
Interval recording	55
Frame by frame recording	
- Cut recording	57

Advanced Playback Operations

Playing back a tape with picture effects	
.....	58
Playing back a tape with digital effects	
.....	59
Enlarging images recorded on tapes	
- Tape PB ZOOM	60
Quickly locating a scene using the zero set memory function	61
Searching the boundaries of recorded tape by title - Title search	62
Searching a recording by date	
- Date search	63
Searching for a photo	
- Photo search/Photo scan	65

Editing

Dubbing a tape	67
Dubbing only desired scenes	
- Digital program editing (on tapes)	69
Using with analog video unit and your computer	
- Signal convert function	80
Recording video or TV programs	81
Inserting a scene from a VCR	
- Insert editing	84
Audio dubbing	86
Superimposing a title	90
Making your own titles	93
Labeling a cassette	94

Customizing Your Camcorder

Changing the menu settings	96
----------------------------------	----

"Memory Stick" Operations

Using a "Memory Stick"	
- introduction	104
Recording still images on "Memory Stick"s	
- Memory Photo recording	112
Recording an image from a tape as a still image	118
Superimposing a still image in the "Memory Stick" on an image	
- MEMORY MIX	121
Recording moving pictures on "Memory Stick"s	
- MPEG movie recording	126

Table of contents

Recording a picture from a tape as a moving picture	128
Recording edited pictures as a moving picture – Digital program editing (on “Memory Stick”s)	132
Copying still images from a tape – Photo save	135
Viewing a still image – Memory photo playback	136
Viewing a moving picture – MPEG movie playback	139
Viewing images using computer	141
Copying the image recorded on “Memory Stick”s to tapes	147
Enlarging still images recorded on “Memory Stick”s – Memory PB ZOOM	148
Playing back images in a continuous loop – SLIDE SHOW	149
Preventing accidental erasure – Image protection	150
Deleting images	151
Writing a print mark – PRINT MARK	153
Using the optional printer	154

Using the Network function

Accessing the network	155
-----------------------------	-----

Troubleshooting

Types of trouble and their solutions	156
Self-diagnosis display	162
Warning indicators and messages	163

Additional Information

Usable cassettes	165
About the “InfoLITHIUM” battery pack	167
About i.LINK	169
Using your camcorder abroad	171
Maintenance information and precautions	172
Specifications	177

Quick Reference

Identifying the parts and controls	179
Index	187

Quick Start Guide

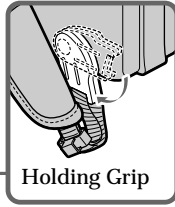

Holding Grip

This chapter introduces you to the basic features of your camcorder. See the page in parentheses “()” for more information.

Pull down the Holding Grip to hold your camcorder as illustrated.

1 Connecting the power cord (p. 15)

Use the battery pack when using your camcorder outdoors (p. 12).

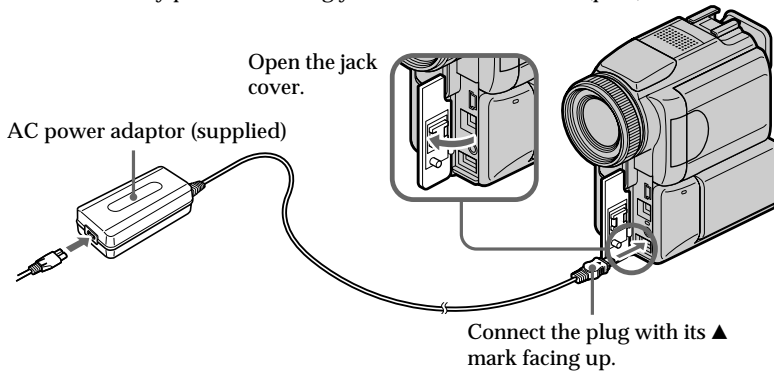

2 Inserting a cassette (p. 19)

- 1 Slide OPEN/
▲ EJECT in the
direction of the
arrow and open the
lid.

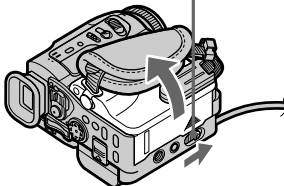

- 2 Push the middle
portion of the back
of the cassette to
insert. Insert the
cassette in a straight
line deeply into the
cassette
compartment with
the window facing
out.

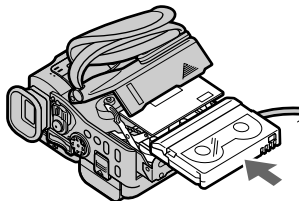

- 3 Close the cassette
compartment by
pressing the **PUSH**
mark on the cassette
compartment.
After the cassette
compartment goes
down completely,
close the lid until it
clicks.

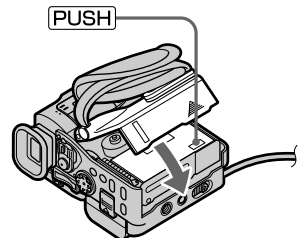

3

Recording a picture (p. 20)

- 1 Remove the lens cap.

Viewing a picture with the viewfinder
Close the LCD panel, and pull out the viewfinder.

- 3 Press OPEN to open the LCD panel.
The picture appears on the screen.

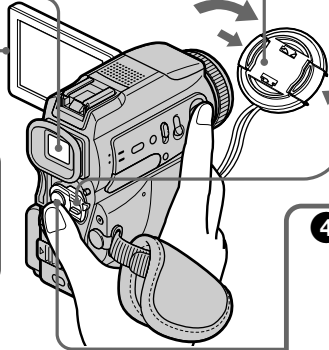

- 2 Set the POWER switch to CAMERA while pressing the small green button.

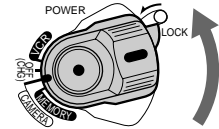

- 4 Press START/STOP. Your camcorder starts recording.
To stop recording, press START/STOP again.

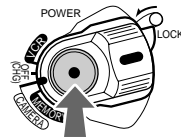

When you purchase your camcorder, the clock setting is set to off. If you want to record the date and time for a picture, set the clock setting before recording (p. 16).

4

Monitoring the playback picture on the LCD screen (p. 31)

- 1 Set the POWER switch to VCR while pressing the small green button.

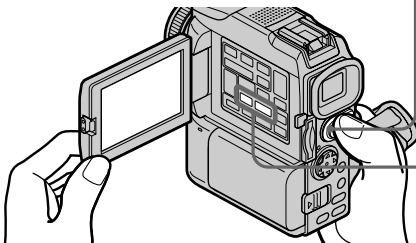
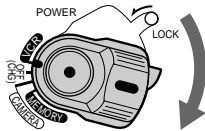

- 2 Press ◀◀ to rewind the tape.



- 3 Press ▶ to start playback.



NOTE

Do not pick up your camcorder by holding the viewfinder, the flash, the LCD panel or the battery pack.

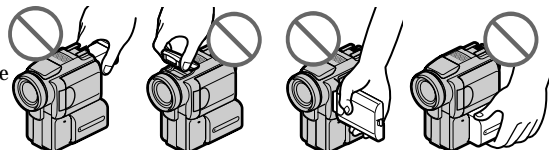

Using this manual

The instructions in this manual are for the two models listed in the table below. Before you start reading this manual and operating your camcorder, check the model number by looking at the bottom of your camcorder. (DCR-PC120BT is marked as DCR-PC120 on the bottom of this unit.) The DCR-PC120BT is the model used for illustration purposes. Otherwise, the model name is indicated in the illustrations. Any differences in operation are clearly indicated in the text, for example, “DCR-PC120BT only”.

As you read through this manual, buttons and settings on your camcorder are shown in capital letters.

e.g. Set the POWER switch to CAMERA.

When you carry out an operation, you can hear a beep sound to indicate that the operation is being carried out.

Types of differences

DCR-	PC115	PC120BT
Network function	—	●

- Provided
- Not provided

Note on Cassette Memory

Your camcorder is based on the DV format. You can only use mini DV cassettes with your camcorder. We recommend that you use a tape with cassette memory **CM**.

The functions which require different operations depending on whether the tape has the cassette memory or not are:

- End search (p. 30)
- Date search (p. 63)
- Photo search (p. 65)

The functions you can operate only with the cassette memory are:

- Title search (p. 62)
- Superimposing a title (p. 90)
- Labeling a cassette (p. 94)

For details, see page 165.



You see this mark in the introduction of the features that are operated only with cassette memory.

Tapes with cassette memory are marked by **CM** (Cassette Memory).

Note on TV color systems

TV color systems differ from country to country. To view your recordings on a TV, you need an NTSC system-based TV.

Copyright precautions

Television programs, films, video tapes, and other materials may be copyrighted. Unauthorized recording of such materials may be contrary to the provision of the copyright laws.

Precautions on camcorder care

Lens and LCD screen/finder (on mounted models only)

- The LCD screen and the finder are manufactured using extremely high-precision technology, so over 99.99% of the pixels are operational for effective use. However, there may be some tiny black points and/or bright points (white, red, blue or green in color) that constantly appear on the LCD screen and the finder. These points are normal in the manufacturing process and do not affect the recording in any way.
- Do not let your camcorder get wet. Keep your camcorder away from rain and sea water. Letting your camcorder get wet may cause your camcorder to malfunction. Sometimes this malfunction cannot be repaired [a].
- Never leave your camcorder exposed to temperatures above 60°C (140°F), such as in a car parked in the sun or under direct sunlight [b].
- Be careful when placing the camera near a window or outdoors. Exposing the LCD screen, the finder or the lens to direct sunlight for long periods may cause malfunctions [c].
- Do not directly shoot the sun. Doing so might cause your camcorder to malfunction. Take pictures of the sun in low light conditions such as dusk [d].

[a]



[b]

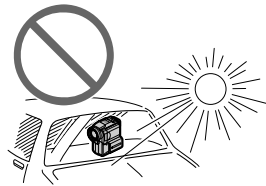

[c]

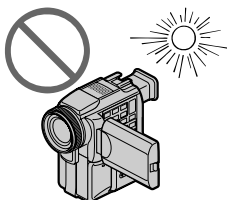

[d]

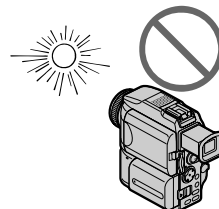

Step 1 Preparing the power supply

Installing the battery pack

- (1) While sliding BATT RELEASE in the direction of the arrow ❶, slide the battery terminal cover in the direction of the arrow ❷.
- (2) Insert the battery pack in the direction of the arrow until it clicks.

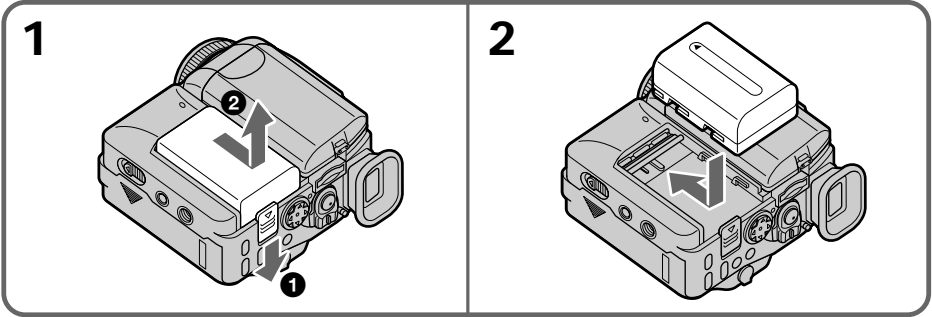

To remove the battery pack

The battery pack is removed in the same way as the battery terminal cover.

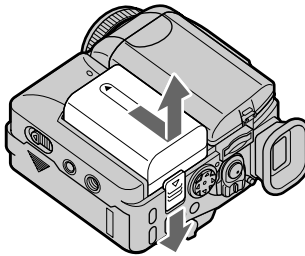

When you store your camcorder

To protect the battery terminals, install the battery terminal cover after the battery pack is removed.

Step 1 Preparing the power supply

Charging the battery pack

Use the battery pack after charging it for your camcorder.
Your camcorder operates only with the “InfoLITHIUM” battery pack (M series).
See page 167 for details of “InfoLITHIUM” battery pack.

- (1) Open the jack cover and connect the AC power adaptor supplied with your camcorder to the DC IN jack with the plug's ▲ mark facing up.
- (2) Connect the power cord to the AC power adaptor.
- (3) Connect the power cord to the wall outlet.
- (4) Set the POWER switch to OFF (CHG). The CHG lamp lights up when the charge begins. After the charge is completed, the CHG lamp goes out. (full charge)

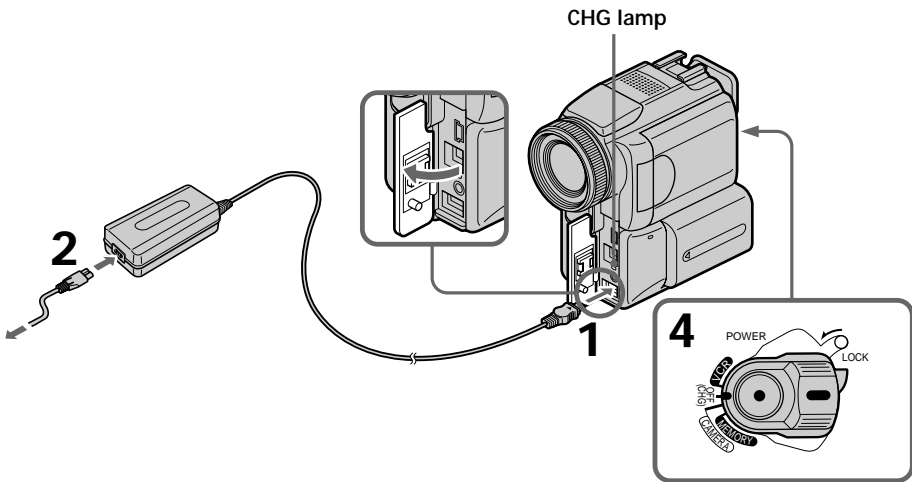

After charging the battery pack

Disconnect the AC power adaptor from the DC IN jack on your camcorder.

Note

Prevent metallic objects from coming into contact with the metal parts of the DC plug of the AC power adaptor. This may cause a short-circuit, damaging the AC power adaptor.

While charging the battery pack, the CHG lamp flashes in the following cases:

- The battery pack is not installed correctly.
- Something is wrong with the battery pack.

When you use the AC power adaptor

Place the AC power adaptor near a wall outlet. If any trouble occurs with this unit, disconnect the plug from a wall outlet as soon as possible to cut off the power.

Step 1 Preparing the power supply

Charging time

Battery pack	Full charge
NP-FM50 (supplied)	150
NP-FM70	240
NP-FM90	330
NP-FM91	360

The charging time may increase if the battery's temperature is extremely high or low because of the ambient temperature.

Approximate minutes at 25°C (77°F) to charge an empty battery pack

Recording time

Battery pack	Recording with the viewfinder		Recording with the LCD screen	
	Continuous*	Typical**	Continuous*	Typical**
NP-FM50 (supplied)	130	75	110	60
NP-FM70	270	155	230	130
NP-FM90	410	235	355	205
NP-FM91	475	275	410	235

Approximate minutes when you use a fully charged battery

* Approximate continuous recording time at 25°C (77°F). The battery life will be shorter if you use your camcorder in a cold environment.

** Approximate number of minutes when recording while you repeat recording start/stop, zooming and turning the power on/off. The actual battery life may be shorter.

Playing time

Battery pack	Playing time on LCD screen	Playing time with LCD closed
NP-FM50 (supplied)	150	185
NP-FM70	310	385
NP-FM90	475	580
NP-FM91	550	670

Approximate minutes when you use a fully charged battery

Approximate continuous playing time at 25°C (77°F). The battery life will be shorter if you use your camcorder in a cold environment.

Step 1 Preparing the power supply

If the power goes off although the battery remaining indicator indicates that the battery pack has enough power to operate

Charge the battery pack fully again so that the indication on the battery remaining indicator is correct.

Recommended charging temperature

We recommend charging the battery pack in an ambient temperature of between 10°C to 30°C (50°F to 86°F).

What is "InfoLITHIUM"?

The "InfoLITHIUM" is a lithium ion battery pack which can exchange data such as battery consumption with compatible electronic equipment. This unit is compatible with the "InfoLITHIUM" battery pack (M series). Your camcorder operates only with the "InfoLITHIUM" battery. "InfoLITHIUM" M series battery packs have the

 mark.

"InfoLITHIUM" is a trademark of Sony Corporation.

Connecting to a wall outlet

When you use your camcorder for a long time, we recommend that you power it from a wall outlet using the AC power adaptor.

- (1) Open the jack cover. Connect the AC power adaptor supplied with your camcorder to the DC IN jack on your camcorder with the plug's ▲ mark facing up.
- (2) Connect the power cord to the AC power adaptor.
- (3) Connect the power cord to a wall outlet.

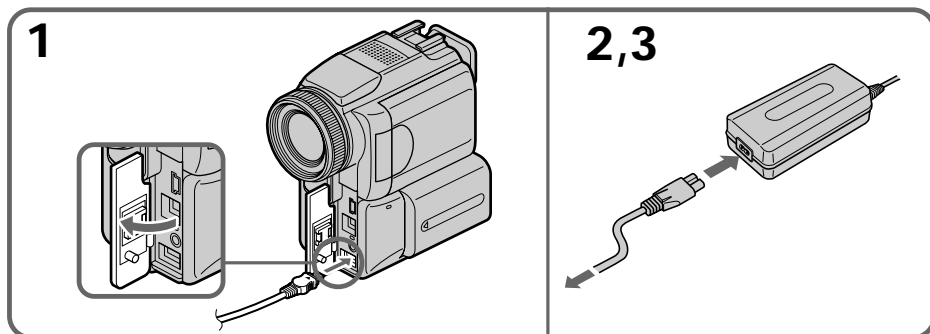

PRECAUTION

The set is not disconnected from the AC power source (house current) as long as it is connected to the wall outlet, even if the set itself has been turned off.

Notes

- The AC power adaptor can supply power even if the battery pack is attached to your camcorder.
- The DC IN jack has "source priority." This means that the battery pack cannot supply any power if the power cord is connected to the DC IN jack, even when the power cord is not plugged into a wall outlet.

Using a car battery

Use Sony DC Adaptor/Charger (optional).

Refer to the operating instructions of the DC Adaptor/Charger for further information.

Step 2 Setting the date and time

Set the date and time settings when you use your camcorder for the first time. "CLOCK SET" will be displayed each time that you set the POWER switch to CAMERA or MEMORY unless you set the date and time settings.

If you do not use your camcorder for about three months, the date and time settings may be released (bars may appear) because the built-in rechargeable battery installed in your camcorder will have been discharged (p. 174).

Set the area, the daylight saving time, year, month, day, hour and then the minute, in that order.

- (1) Set the POWER switch to CAMERA or MEMORY, then press MENU to display the menu settings.
- (2) Press ▲/▼ on the control button to select , then press ● or ►.
- (3) Press ▲/▼ on the control button to select CLOCK SET, then press ● or ►.
- (4) Press ▲/▼ on the control button to adjust the desired area (where you are), then press ●.
- (5) Press ▲/▼ on the control button to select whether or not the time is daylight saving time, then press ●.
Select OFF if the time is not daylight saving time. Select ON if it is.
- (6) Press ▲/▼ on the control button to adjust the desired year, then press ●.

The year changes as follows:

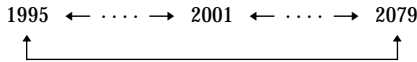

- (7) Set the month, day and hour by pressing ▲/▼ on the control button and pressing ●.
- (8) Set the minute by pressing ▲/▼ on the control button and pressing ● by the time signal. The clock starts to move.
- (9) Press MENU to make the menu settings disappear.

Step 2 Setting the date and time

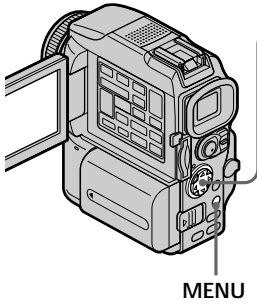

<p>2</p> <pre> MANUAL SET P PROGRAM AE P EFFECT D EFFECT WHI BAL AUTO SHTR ETC [MENU]:END </pre>	<pre> SETUP MENU CLOCK SET ---:--:-- LTR SIZE DEMO MODE RETURN [MENU]:END </pre>
<p>3</p> <pre> SETUP MENU CLOCK SET ---:--:-- LTR SIZE DEMO MODE RETURN [MENU]:END </pre>	<pre> CLOCK SET AREA 1 GMT +0.0 Lisbon, London DST OFF DATE Y M D [EXEC]:NEXT ITEM </pre>
<p>4</p> <pre> CLOCK SET AREA26 GMT -5.0 NewYork, Bogota DST OFF DATE Y M D [EXEC]:NEXT ITEM </pre>	<p>5</p> <pre> CLOCK SET AREA26 GMT -5.0 NewYork, Bogota DST OFF DATE Y M D [EXEC]:NEXT ITEM </pre>
<p>6</p> <pre> CLOCK SET AREA26 GMT -5.0 NewYork, Bogota DST OFF DATE Y M D 12:00AM 2001 JAN [EXEC]:NEXT ITEM </pre>	<pre> CLOCK SET AREA26 GMT -5.0 NewYork, Bogota DST OFF DATE Y M D 12:00AM 2001 JAN [EXEC]:NEXT ITEM </pre>
<p>8</p> <pre> CLOCK SET AREA26 GMT -5.0 NewYork, Bogota DST OFF DATE Y M D 5:30PM 2001 JUL 4 [EXEC]:END </pre>	<pre> SETUP MENU CLOCK SET JUL 4 2001 LTR SIZE 5:30:00 PM DEMO MODE RETURN [MENU]:END </pre>

Getting started

Note

Instead of DST, SUMMERTIME is displayed on the screen for some models.

If you do not set the date and time

“---:--:--” and “--- - - - -” are recorded on the data code of the tape and the “Memory Stick.”

When using your camcorder abroad

Set the clock to the local time (p. 18).

Note on the time indicator

The internal clock of your camcorder operates on a 12-hour cycle.

- 12:00 AM stands for midnight.
- 12:00 PM stands for noon.

Step 2 Setting the date and time

Simple setting of clock by time difference

You can easily set the clock to the local time by setting a time difference. Select AREA SET, DST SET* in the menu settings. See page 103 for more information.

* Instead of DST, SUMMERTIME is displayed on the screen for some models.

World time differences

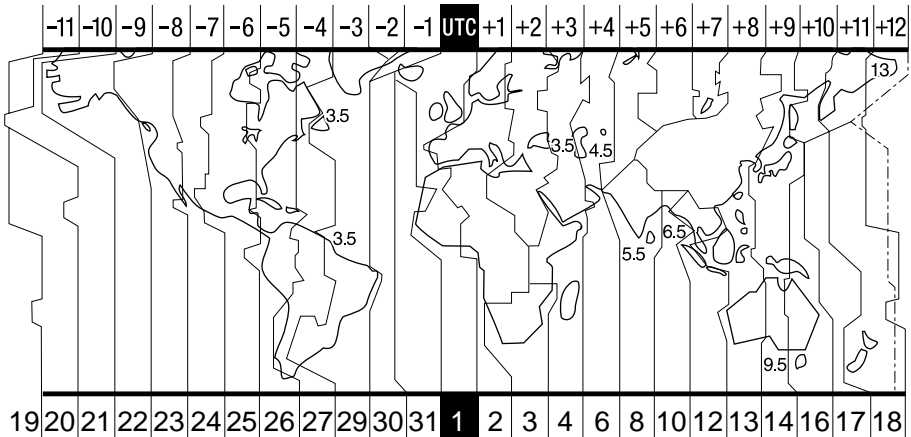

AREA	Time difference	Area or country
1	GMT	Lisbon-London
2	+01:00	Berlin-Paris
3	+02:00	Helsinki-Cairo
4	+03:00	Moscow-Nairobi
5	+03:30	Tehran
6	+04:00	Abu Dhabi-Baku
7	+04:30	Kabul
8	+05:00	Karachi-Islamabad
9	+05:30	Calcutta-New Delhi
10	+06:00	Almaty-Dhaka
11	+06:30	Rangoon
12	+07:00	Bangkok-Jakarta
13	+08:00	Hongkong-Singapore
14	+09:00	Seoul-Tokyo
15	+09:30	Adelaide-Darwin
16	+10:00	Melbourne-Sydney

AREA	Time difference	Area or country
17	+11:00	Solomon Is
18	+12:00	Fiji-Wellington
19	-12:00	Eniwetok-Kwajalein
20	-11:00	Midway Is.-Samoa
21	-10:00	Hawaii
22	-09:00	Alaska
23	-08:00	LosAngeles-Tijuana
24	-07:00	Denver-Arizona
25	-06:00	Chicago-MexicoCity
26	-05:00	New York-Bogota
27	-04:00	Santiago
28	-03:30	St. John's
29	-03:00	Brasilia-Montevideo
30	-02:00	Fernando de Noronha
31	-01:00	Azores

To adjust a time difference

Select AREA SET in the menu setting, and select and decide upon an area or country you want to adjust to.

Step 3 Inserting a cassette

- (1) Install the power source.
- (2) Slide OPEN/▲ EJECT in the direction of the arrow and open the lid.
The cassette compartment automatically lifts up and opens.
- (3) Push the middle portion of the back of the cassette to insert.
Insert the cassette in a straight line deeply into the cassette compartment with the window facing out.
- (4) Close the cassette compartment by pressing the **PUSH** mark on the cassette compartment. The cassette compartment automatically goes down.
- (5) After the cassette compartment goes down completely, close the lid until it clicks.

Getting started

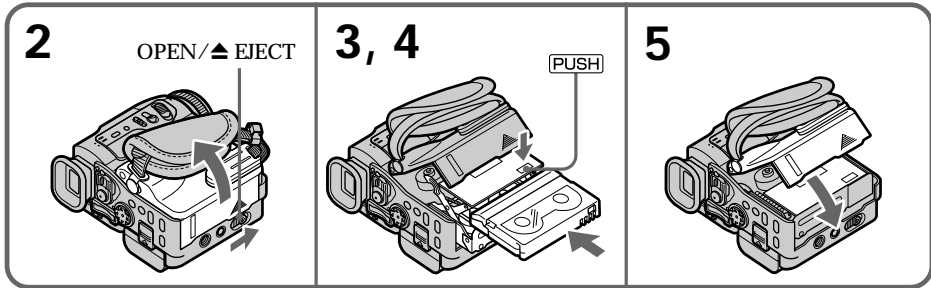

To eject a cassette

Follow the procedure above, and take out the cassette in step 3.

Notes

- Do not press the cassette compartment down forcibly. Doing so may cause a malfunction.
- The cassette compartment may not be closed when you press any part of the lid other than the **PUSH** mark.

When you use cassette with cassette memory

Read the instruction about cassette memory to use this function properly (p. 165).

To prevent accidental erasure

Slide the write-protect tab on the cassette to expose the red mark.

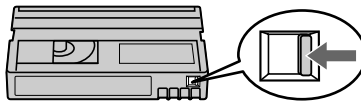

Recording a picture

Your camcorder automatically focuses for you.

- (1) Remove the lens cap by pressing both knobs on its sides and pull the lens cap string to fix it.
- (2) Install the power source and insert a cassette. See “Step 1” to “Step 3” for more information (p. 12 to 19).
- (3) Pull down the Holding Grip.
Hold your camcorder firmly as illustrated.
- (4) Set the POWER switch to CAMERA while pressing the small green button.
Your camcorder is set to the standby mode.
- (5) Press OPEN to open the LCD panel. The viewfinder automatically turns off.
- (6) Press START/STOP. Your camcorder starts recording. The REC indicator appears. The camera recording lamp located on the front of your camcorder lights up. To stop recording, press START/STOP again.

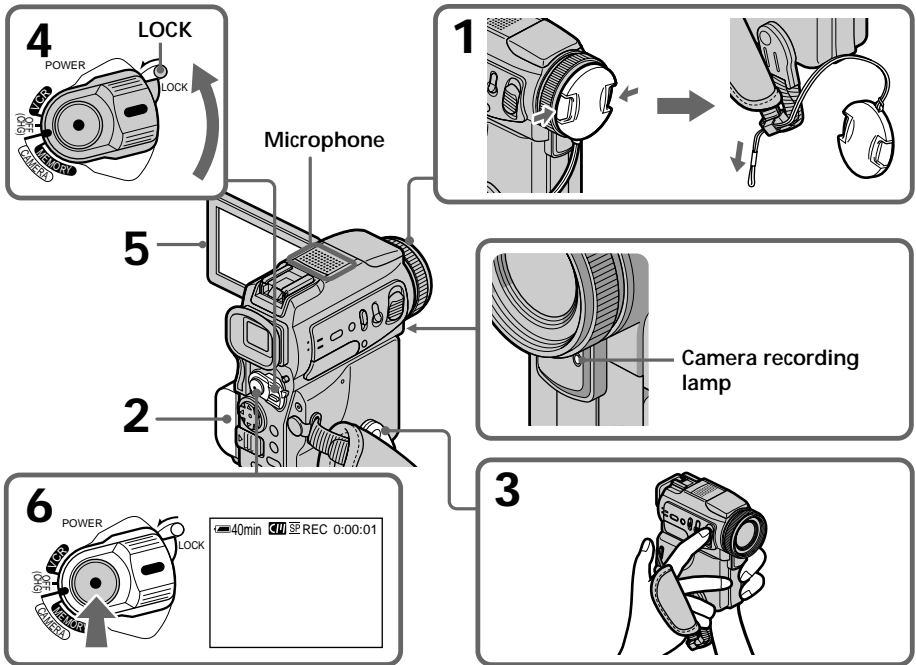

Notes

- Fasten the grip strap firmly.
- Do not touch the built-in microphone during recording.

Note on Recording mode

Your camcorder records and plays back in the SP (standard play) mode and in the LP (long play) mode. Select SP or LP in the menu settings (p. 96). In the LP mode, you can record 1.5 times as long as in the SP mode.

When you record a tape in the LP mode on your camcorder, we recommend playing the tape on your camcorder.

Recording a picture

Note on the LOCK switch

When you slide the LOCK switch to the left, the POWER switch can no longer be set to MEMORY accidentally. LOCK switch is set to the right as a default setting.

To enable smooth transition

Transition between the last scene you recorded and the next scene is smooth as long as you do not eject the cassette even if you turn off your camcorder.

However, check the following:

- Do not mix recordings in the SP mode and ones in the LP mode on one tape.
- When you change the battery pack, set the POWER switch to OFF (CHG).
- When you use a tape with cassette memory, however, you can make the transition smooth even after ejecting the cassette if you use the END SEARCH function (p. 30).

If you leave your camcorder in the standby mode for five minutes while the cassette is inserted

Your camcorder automatically turns off. This is to save battery power and to prevent battery and tape wear. To resume the standby mode, set the POWER switch to OFF (CHG), and to CAMERA again. However, your camcorder does not turn off automatically while the cassette is not inserted.

When you record in the SP and LP modes on one tape or you record in the LP mode

- The transition between scenes may not be smooth.
- The playback picture may be distorted or the time code may not be written properly between scenes.

Recording data

The recording data (date/time or various settings when recorded) are not displayed while recording. However, they are recorded automatically onto the tape. To display the recording data, press DATA CODE on the Remote Commander during playback.

The battery use time when you record using the LCD screen

The battery time is slightly shorter than the shooting time using the viewfinder.

After recording

- (1) Set the POWER switch to OFF (CHG).
- (2) Close the LCD panel.
- (3) Set the Holding Grip back to the previous position.
- (4) Eject the cassette.
- (5) Remove the battery pack.
- (6) Attach the battery terminal cover.

Recording a picture

Adjusting the LCD screen

The LCD screen can be opened up to 90 degrees.

The LCD panel moves about 90 degrees to the viewfinder side and about 180 degrees to the lens side.

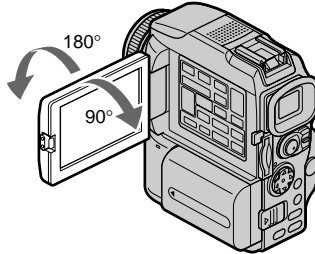

When closing the LCD panel, set it vertically, and swing it into the camcorder body.

Note

When using the LCD screen except in the mirror mode, the viewfinder automatically turns off (p. 25).

When you use the LCD screen outdoors in direct sunlight

The LCD screen may be difficult to see. If this happens, we recommend that you use the viewfinder.

When you adjust the angle of the LCD panel

Make sure if the LCD panel is opened up to 90 degrees.

Adjusting the brightness of the LCD screen

- (1) Set the POWER switch to CAMERA, VCR or MEMORY. Press MENU, then select and decide upon LCD BRIGHT in  with the control button (p. 96). The bar indicator appears.
- (2) Press ◀▶ on the control button to adjust the brightness of the LCD screen, then press ●.

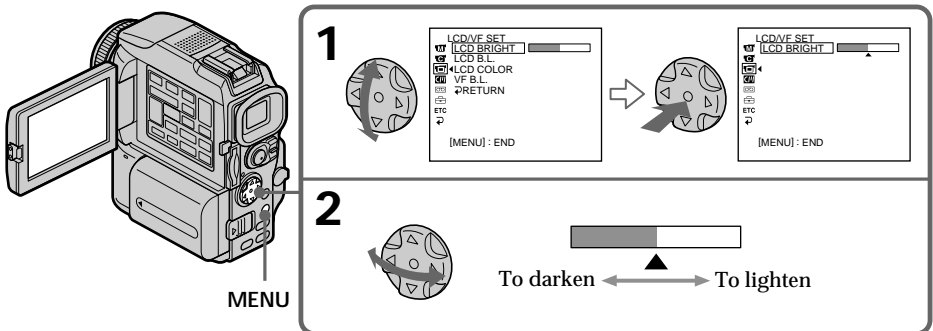

LCD screen backlight

You can change the brightness of the backlight. Select LCD B.L. in the menu settings when using the battery pack (p. 96).

Recording a picture

Adjusting the viewfinder

If you record pictures with the LCD panel closed, check the picture with the viewfinder. Adjust the viewfinder lens to your eyesight so that the indicators in the viewfinder come into sharp focus.

Pull out the viewfinder and move the viewfinder lens adjustment lever.

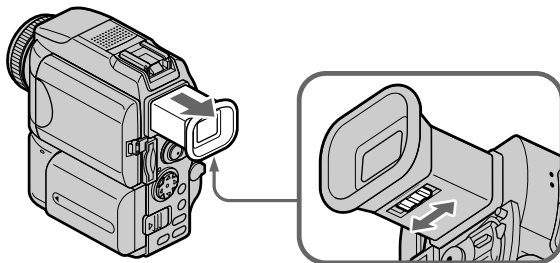

Viewfinder backlight

You can change the brightness of the backlight. Select VF B.L. in the menu settings when using the battery pack (p. 96).

Attaching the supplied lens hood

To record fine pictures under strong light, we recommend attaching the lens hood. Also the lens cap can be attached even with the lens hood on.

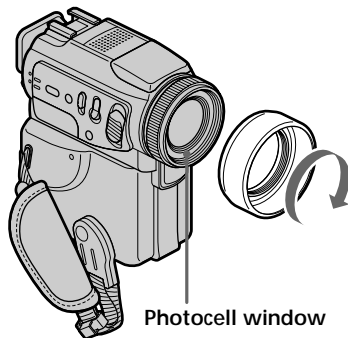

Notes

- When you use the Remote Commander and the lens hood, the Remote Commander may not function properly because the lens hood blocks the infrared rays from the Remote Commander. In such case, remove the lens hood from your camcorder.
- You cannot attach filters or other objects onto the lens hood. If you do so forcibly, you will no longer be able to remove filters or other objects from the lens hood.

When you use the filter (optional)

- The shadow of the lens hood may appear in the corners of the screen.
- The flash may not be adjusted correctly if the photocell window is covered.

Recording a picture

Using the zoom feature

Move the power zoom lever a little for a slower zoom. Move it further for a faster zoom. Using the zoom function sparingly results in better-looking recordings.

“T” side: for telephoto (subject appears closer)

“W” side: for wide-angle (subject appears farther away)

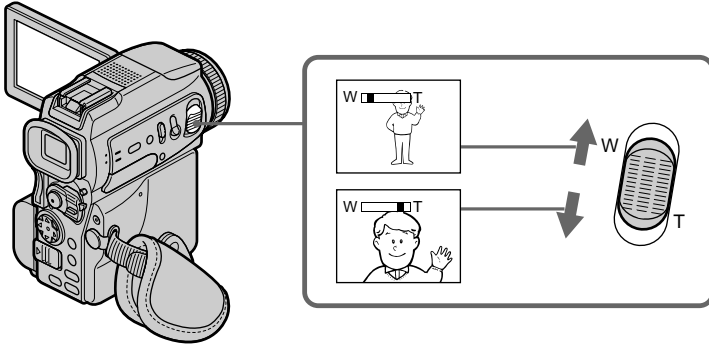

To use zoom greater than 10×

Zoom greater than 10× is performed digitally. To activate digital zoom, select the digital zoom power in D ZOOM in the menu settings (p. 96). The digital zoom function is set to OFF as a default setting.

The right side of the bar shows the digital zooming zone.

The digital zooming zone appears when you select the digital zoom power in the menu settings.

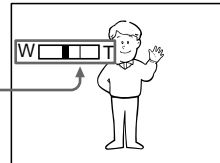

When you shoot close to a subject

If you cannot get a sharp focus, move the power zoom lever to the “W” side until the focus is sharp. You can shoot a subject that is at least about 80 cm (about 2 feet 5/8 inch) away from the lens surface in the telephoto position, or about 1 cm (about 1/2 inch) away in the wide-angle position.

Notes on digital zoom

- Digital zoom starts to function when zoom exceeds 10×.
- The picture quality deteriorates as you move the power zoom lever towards the “T” side.

When the POWER switch is set to MEMORY

You cannot use the digital zoom.

Recording a picture

Shooting with the Mirror Mode

This feature allows the camera subject to view him-or herself on the LCD screen. The subject uses this feature to check his or her own image on the LCD screen while you look at the subject in the viewfinder.

Set the POWER switch to CAMERA or MEMORY.

Pull out the viewfinder and rotate the LCD screen 180 degrees.

The ☺ indicator appears in the viewfinder and on the LCD screen.

■● appears in the standby mode, and ● appears in the recording mode. Some of other indicators appear mirror-reversed and others are not displayed.

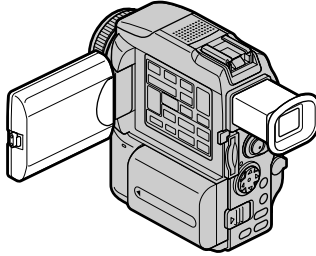

Picture in the mirror mode

The picture on the LCD screen is a mirror-image. However, the picture will be normal when recorded.

During recording in the mirror mode

ZERO SET MEMORY on the Remote Commander does not work.

Recording a picture

Indicators displayed in the recording mode

The indicators are not recorded on tapes.

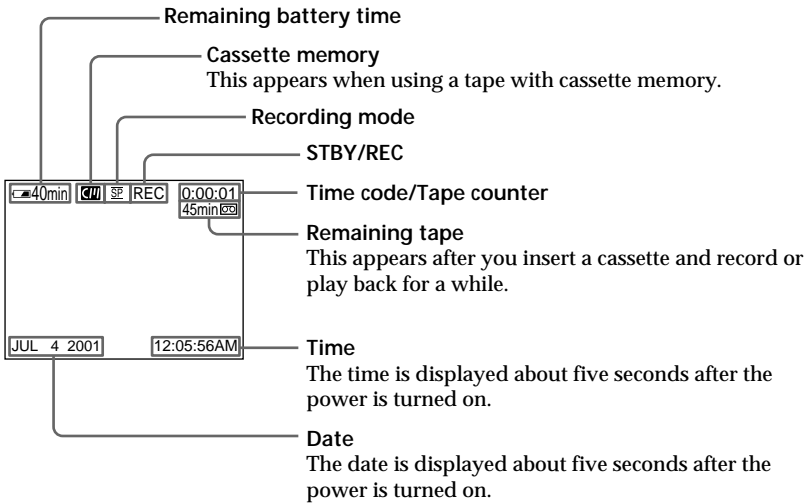

Remaining battery time indicator during recording

The remaining battery time indicator roughly indicates the continuous recording time. The indicator may not be correct, depending on the conditions in which you are recording. When you close the LCD panel and open it again, it takes about one minute for the correct remaining battery time in minutes to be displayed.

Time code

The time code indicates the recording or playback time, "0:00:00" (hours : minutes : seconds) in CAMERA mode and "0:00:00:00" (hours : minutes : seconds : frames) in VCR mode. You cannot rewrite only the time code.

Remaining tape indicator

The indicator may not be displayed accurately depending on the tape.

Recording data

The recording data (date/time or various settings when recorded) are not displayed while recording. However, they are recorded automatically onto the tape. To display the recording data, press DATA CODE on the Remote Commander during playback.

Recording a picture

Shooting backlit subjects - BACK LIGHT

When you shoot a subject with the light source behind the subject or a subject with a light background, use the backlight function.

Set the POWER switch to CAMERA or MEMORY, press BACK LIGHT. The  indicator appears on the screen. To cancel, press BACK LIGHT again.

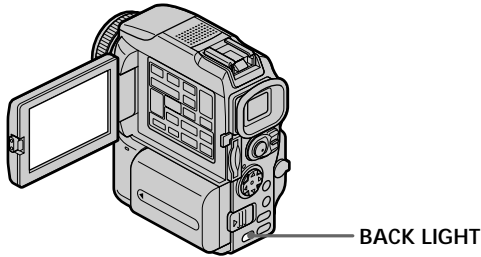

If you press EXPOSURE when shooting backlit subjects
The backlight function will be canceled.

Shooting in the dark - NightShot/Super NightShot

The NightShot function enables you to shoot a subject in a dark place. For example, you can satisfactorily record the environment of nocturnal animals for observation when you use this function.

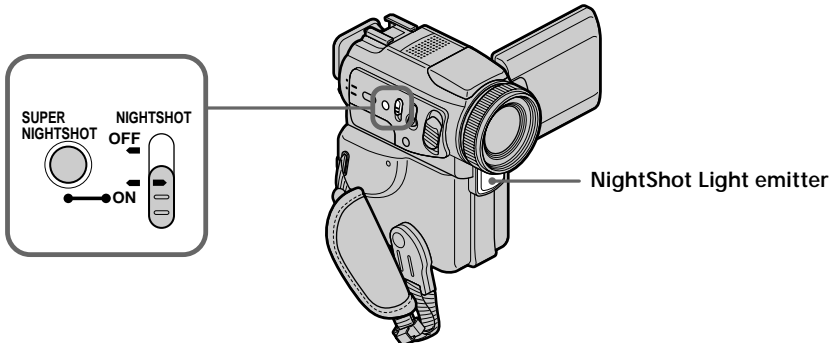

Set the POWER switch to CAMERA or MEMORY, slide NIGHTSHOT to ON.  and "NIGHTSHOT" indicators flash on the screen. To cancel the NightShot function, slide NIGHTSHOT to OFF.



Recording a picture

Using Super NightShot

The Super NightShot mode makes subjects more than 16 times brighter than those recorded in the NightShot mode.

- (1) Set the POWER switch to CAMERA, slide NIGHTSHOT to ON.  and “NIGHTSHOT” indicators flash on the screen.
- (2) Press SUPER NIGHTSHOT.  and “SUPER NIGHTSHOT” indicators flash on the screen.

To cancel the Super NightShot mode, press SUPER NIGHTSHOT again.

Using the NightShot Light

The picture will be clearer with the NightShot Light on. To enable the NightShot Light, set N.S. LIGHT to ON in the menu settings (p. 96).
(The default setting is ON.)

Notes

- Do not use the NightShot function in bright places (ex. the outdoors in the daytime). This may cause your camcorder to malfunction.
- When you keep NIGHTSHOT set to ON in normal recording, the picture may be recorded in incorrect or unnatural colors.
- If focusing is difficult with the autofocus mode when using the NightShot function, focus manually.
- Do not cover the NightShot Light emitter when using the NightShot function.
- Detach the lens hood when you shoot with the NightShot Light since the lens hood may block the NightShot Light.

While using the NightShot function, you cannot use the following functions:

- Exposure
- PROGRAM AE
- White balance
- HOLOGRAM AF

While using the Super NightShot function

The shutter speed is automatically adjusted depending on the brightness. At that time, the moving picture may be slow down.

While using the Super NightShot function, you cannot use the following functions:

- Fader
- Digital effect
- PROGRAM AE
- Exposure
- White balance
- Recording with the flash
- HOLOGRAM AF

When the POWER switch is set to MEMORY

You cannot use the Super NightShot function.



NightShot Light

NightShot Light rays are infrared and so are invisible. The maximum shooting distance using the NightShot Light is about 3 m (10 feet).

Recording a picture

Self-timer recording

Recording with the self-timer starts in 10 seconds automatically. You can also use the Remote Commander for this operation.

- (1) Press  (self-timer) in the standby mode. The  (self-timer) indicator appears on the screen.
- (2) Press START/STOP.
Self-timer starts counting down from ten with a beep sound. In the last two seconds of the countdown, the beep sound gets faster, then recording starts automatically.

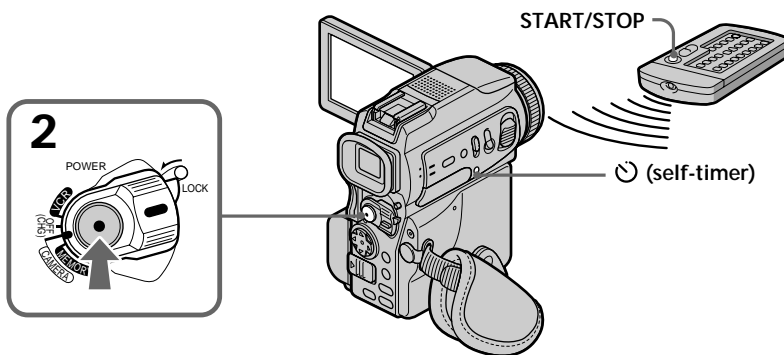

To stop the countdown



Press START/STOP.

To restart the countdown, press START/STOP again.

To record still images on tapes using the self-timer

Press PHOTO in step 2 (p. 39).

To cancel self-timer recording

Press  (self-timer) so that the  indicator disappears from the screen while your camcorder is in the standby mode.

Note

The self-timer recording mode is automatically canceled when:

- Self-timer recording is finished.
- The POWER switch is set to OFF (CHG) or VCR.

When the POWER switch is set to MEMORY

You can also record still images on "Memory Stick"s with the self-timer (p. 117).

Checking the recording

- END SEARCH / EDITSEARCH / Rec Review

You can use these buttons to check the recorded picture or shoot so that the transition between the last recorded scene and the next scene you record is smooth.

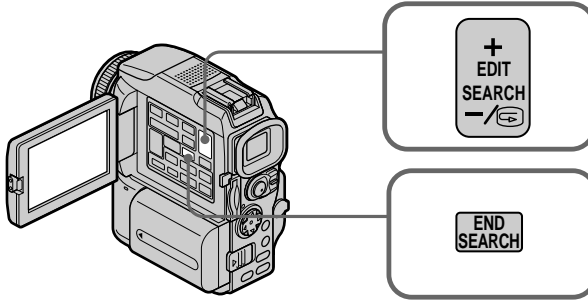

END SEARCH

You can go to the end of the recorded section after you record.

Press END SEARCH in the standby mode.

The last five seconds of the recorded section are played back and your camcorder returns to the standby mode. You can monitor the sound from the speaker or headphones.

EDITSEARCH

You can search for the next recording start point.

Hold down the + · - / ⊞ side of EDITSEARCH in the standby mode. The recorded section is played back.

+ : to go forward

- / ⊞ : to go backward

Release EDITSEARCH to stop playback. If you press START/STOP, re-recording begins from the point you released EDITSEARCH. You cannot monitor the sound.

Rec Review

You can check the last recorded section.

Press the - / ⊞ side of EDITSEARCH momentarily in the standby mode.

The section you have stopped most recently will be played back for a few seconds, and then your camcorder will return to the standby mode. You can monitor the sound from the speaker or headphones.

End search function

When you use a tape without cassette memory, the end search function does not work once you eject the cassette after you have recorded on the tape. If you use a tape with cassette memory, the end search function works even once you eject the cassette.

If a tape has a blank portion in the recorded portions

The end search function may not work correctly.

Playing back a tape

You can monitor the playback picture on the screen. If you close the LCD panel, you can monitor the playback picture in the viewfinder. You can control playback using the Remote Commander supplied with your camcorder.

- (1) Install the power source and insert the recorded tape.
 - (2) Set the POWER switch to VCR while pressing the small green button.
 - (3) Open the LCD panel while pressing OPEN.
 - (4) Press ◀◀ to rewind the tape.
 - (5) Press ▶▶ to start playback.
 - (6) To adjust the volume, press either of the two buttons on VOLUME.
- When you close the LCD panel, sound is muted.

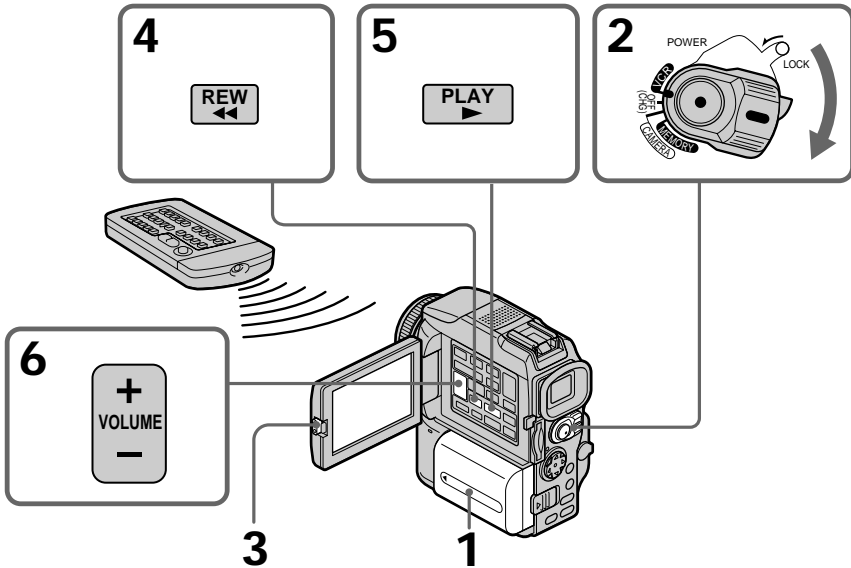

To stop playback

Press ■.

When monitoring on the LCD screen

You can turn the LCD panel over and move it back to the camcorder body with the LCD screen facing out.

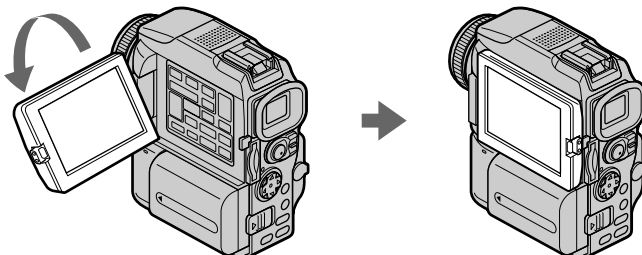

Playing back a tape

If you leave the power on for a long time
Your camcorder gets warm. This is not a malfunction.

When you open or close the LCD panel
Open or close the LCD panel vertically.

To display the screen indicators – Display function

Press DISPLAY. The indicators appear on the screen. To make the indicators disappear, press DISPLAY again.

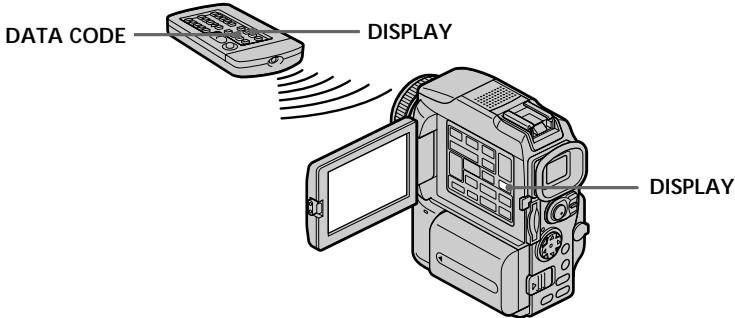

About date/time and various settings

Your camcorder automatically records not only images on the tape but also the recording data (date/time or various settings when recorded) (Data code).
Use the Remote Commander for this operation.

- ① Set the POWER switch to VCR, then playback a tape.
- ② Press DATA CODE on the Remote Commander.

The display changes as follows:

date/time → various settings (SteadyShot, exposure, white balance, gain, shutter speed, aperture value) → no indicator

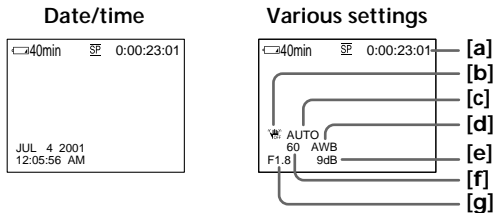

- [a] Tape counter
- [b] SteadyShot OFF
- [c] Exposure mode
- [d] White balance
- [e] Gain
- [f] Shutter speed
- [g] Aperture value

Not to display various settings

Set DATA CODE to DATE in the menu settings (p. 96).

The display changes as follows when you press DATA CODE on the Remote Commander: date/time ↔ no indicator

Playing back a tape

Various settings

Various settings is your camcorder's information when you have recorded. In the recording mode, the various settings will not be displayed.

When you use the data code function, bars (-- -- --) appear if:

- A blank portion of the tape is being played back.
- The tape is unreadable due to tape damage or noise.
- The tape was recorded by a camcorder without the date and time set.

Data code

When you connect your camcorder to the TV, the data code appears on the TV screen.

Remaining battery time indicator during playback

The indicator indicates the approximate continuous playback time. The indicator may not be correct, depending on the conditions in which you are playing back. When you close the LCD panel and open it again, it takes about one minute for the correct remaining battery time to be displayed.

Various playback modes

To operate video control buttons, set the POWER switch to VCR.

To playback pause (view a still picture)

Press **II** during playback. To resume normal playback, press **▶** or **II**.

To advance the tape

Press **▶▶** in the stop mode. To resume normal playback, press **▶**.

To rewind the tape

Press **◀◀** in the stop mode. To resume normal playback, press **▶**.

To change the playback direction

Press **<** on the Remote Commander during playback to reverse the playback direction. To resume normal playback, press **▶**.

To locate a scene monitoring the picture (picture search)

Keep pressing **◀◀** or **▶▶** during playback. To resume normal playback, release the button.

To monitor the high-speed picture while advancing or rewinding the tape (skip scan)

Keep pressing **◀◀** while rewinding or **▶▶** while advancing the tape. To resume rewinding or advancing, release the button.

To view the picture at slow speed (slow playback)

Press **▶▶** on the Remote Commander during playback. For slow playback in the reverse direction, press **<**, then press **▶▶** on the Remote Commander. To resume normal playback, press **▶**.

To view the picture at double speed

Press **×2** on the Remote Commander during playback. For double speed playback in the reverse direction, press **<**, then press **×2** on the Remote Commander. To resume normal playback, press **▶**.

Playing back a tape

To view the picture frame-by-frame

Press **II▶** on the Remote Commander in the playback pause mode. For frame-by-frame playback in the reverse direction, press **◀II**. To resume normal playback, press **▶**.

To search the last scene recorded (END SEARCH)

Press **END SEARCH** in the stop mode. The last five seconds of the recorded portion plays back and stops.

In the various playback modes

- Sound is muted.
- The previous picture may remain as a mosaic image during playback.

When the playback pause mode lasts for five minutes

Your camcorder automatically enters the stop mode. To resume playback, press **▶**.

Slow playback

The slow playback can be performed smoothly on your camcorder. However, this function does not work for an output signal through the **Ⓜ** DV jack.

When you play back a tape in reverse

Horizontal noise may appear at the center, or the top and bottom of the screen. This is not a malfunction.

Viewing the recording on TV

Connect your camcorder to your TV with the A/V connecting cable supplied with your camcorder to watch the playback picture on the TV screen. You can operate the video control buttons in the same way as when you monitor playback pictures on the screen. When monitoring the playback picture on the TV screen, we recommend that you power your camcorder from a wall outlet using the AC power adaptor (p. 15). Refer to the operating instructions of your TV.

Open the jack cover. Connect your camcorder to the TV using the A/V connecting cable supplied with your camcorder. Then, set the TV/VCR selector on the TV to VCR.

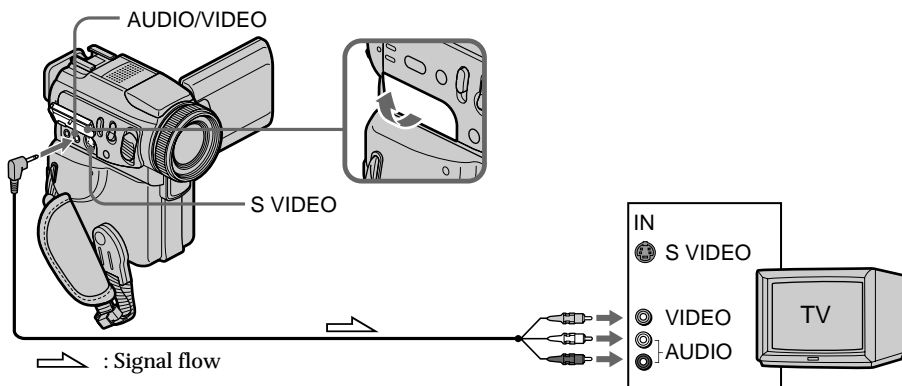

If your TV is already connected to a VCR

Connect your camcorder to the LINE IN input on the VCR by using the A/V connecting cable supplied with your camcorder. Set the input selector on the VCR to LINE.

If your TV or VCR is a monaural type

Connect the yellow plug of the A/V connecting cable to the video input jack and the white or the red plug to the audio input jack on the VCR or the TV. If you connect the white plug, the sound is L (left) signal. If you connect the red plug, the sound is R (right) signal.

If your TV has an S video jack

Pictures can be reproduced more faithfully by using an S video cable (optional). With this connection, you do not need to connect the yellow (video) plug of the A/V connecting cable. Connect the S video cable (optional) to the S video jacks on both your camcorder and the TV.

This connection produces higher quality DV format pictures.

To display the screen indicators on TV

Set DISPLAY to V-OUT/LCD in the menu settings (p. 96).

Then press DISPLAY on your camcorder. To turn off the screen indicators, press DISPLAY on your camcorder again.

Recording a still image on a tape

– Tape Photo recording

You can record an still image like a photograph.

You can record about 510 images in the SP mode and about 765 images in the LP mode on a 60-minute tape.

Besides the operation described here, your camcorder can record still images on “Memory Stick”s (p. 112).

- (1) In the standby mode, keep pressing PHOTO lightly until a still image appears. The CAPTURE indicator appears. Recording does not start yet. To change the still image, release PHOTO, select a still image again, and then press and hold PHOTO lightly.

- (2) Press PHOTO deeper.

The still image on the screen is recorded for about seven seconds. The sound during those seven seconds is also recorded.

The still image is displayed on the screen until recording is completed.

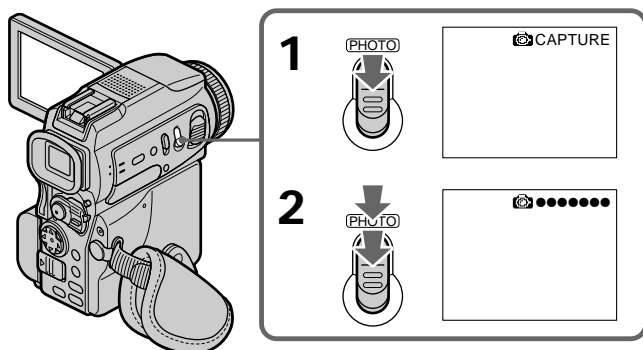

Notes

- During tape photo recording, you cannot change the mode or setting.
- When recording a still image, do not shake your camcorder. The image may fluctuate.
- You cannot use PHOTO during the following operations:
 - Fader
 - Digital effect

If you record a moving subject with tape photo recording function

When you play back the still image on other equipment, the image may fluctuate. This is not a malfunction.

To use the tape photo recording function using the Remote Commander

Press PHOTO on the Remote Commander. Your camcorder records an image on the screen immediately.

To use the tape photo recording function during normal CAMERA recording

You cannot check an image on the screen by pressing PHOTO lightly. Press PHOTO deeper. The still image is then recorded for about seven seconds, and your camcorder returns to the standby mode.

To record clear and less fluctuated still images

We recommend that you record on “Memory Stick”s.

Recording images with the flash

The flash pops up automatically. The default setting is auto (no indicator). To change the flash mode, press the **⚡** (flash) repeatedly until the flash mode indicator appears on the screen.

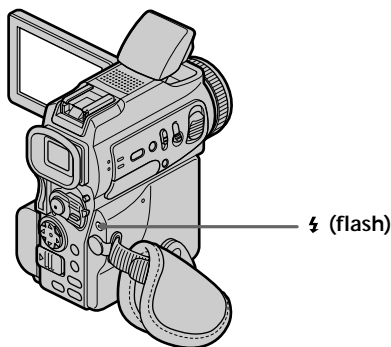

Each press of **⚡** (flash) changes the indicator as follows:

● → **⚡** → **⚡** → No indicator

● Auto red-eye reduction: The flash fires before recording to reduce the red-eye phenomenon.

⚡ Forced flash: The flash fires regardless of the surrounding brightness.

⊗ No flash: The flash does not fire.

The flash is adjusted to the appropriate brightness through the photocell window for the flash. You can also change FLASH LVL to the desired brightness in the menu settings (p. 96). Try recording various images to find the most appropriate setting for FLASH LVL.

Notes

- Attaching the lens hood (supplied) or a conversion lens (optional) may block the light from the flash or cause lens shadow to appear.
- You cannot use an external flash (optional) and the built-in flash at the same time.
- ● (auto red-eye reduction) may not produce the desired effect depending on individual differences, the distance to the subject, the subject not looking at the pre-recording flash or other conditions.
- The flash effect cannot be obtained easily when you use forced flash in a bright location.
- When you record images with the flash, sound may not be recorded clearly.
- When recording with the flash, it takes longer to prepare for image capture. This is because your camcorder starts to charge power for firing after the flash pops up. Darken the surroundings by covering the lens part, and press PHOTO lightly so that your camcorder starts to charge power after the flash pops up.
- If it is not easy to focus on the subject automatically, for example, when recording in the dark, use the focal distance information (p. 53) for focusing manually.

Recording a still image on a tape – Tape Photo recording

When you record images with the flash

The possible shooting distance using the built-in flash is shorter than when you record on “Memory Stick”s.

When playing back images recorded with the flash on other equipment

These images may flicker.

If you leave your camcorder for five or more minutes after disconnecting the power source

Your camcorder returns to the default setting (auto).

You cannot shoot images with the flash during the following operations:

- Low lux of PROGRAM AE
- Super NightShot
- Digital effect
- Fader
- Recording

The flash does not fire even if you select auto (no indicator) and (auto red-eye reduction) during the following operations:

- Exposure
- NightShot
- Spotlight of PROGRAM AE
- Sunset & moon of PROGRAM AE
- Landscape of PROGRAM AE



When you use an external flash (optional) which does not have the auto red-eye reduction function

You cannot select the auto red-eye reduction.

Recording a still image on a tape – Tape Photo recording



Self-timer recording

You can record still images on tapes with the self-timer. You can also use the Remote Commander for this operation.

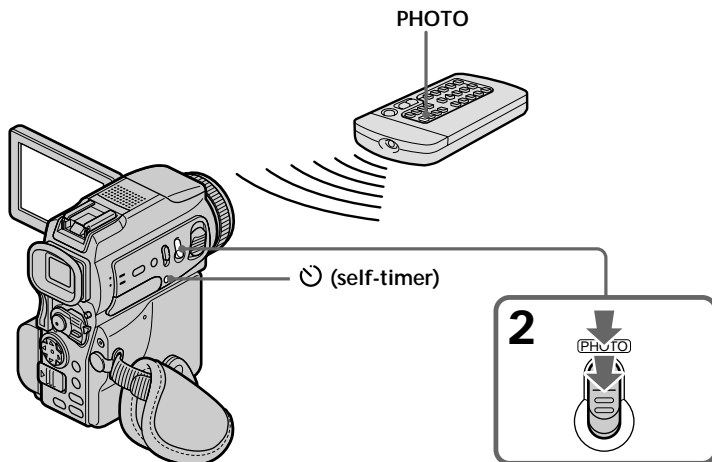
- (1) Press  (self-timer) in the standby mode. The  (self-timer) indicator appears on the screen.
- (2) Press PHOTO deeper.
Self-timer starts counting down from 10 with a beep sound. In the last two seconds of the countdown, the beep sound gets faster, then recording starts automatically.



To cancel self-timer recording

Press  (self-timer) so that the  indicator disappears from the screen while your camcorder is in the standby mode. You cannot cancel the self-timer recording using the Remote Commander.

Note

The self-timer recording mode is automatically canceled when:

- Self-timer recording is finished.
- The POWER switch is set to OFF (CHG) or VCR.

Adjusting the white balance manually

You can manually adjust and set the white balance. This adjustment makes white subjects look white and allows more natural color balance. Normally white balance is automatically adjusted.

- (1) Set the POWER switch to CAMERA or MEMORY. Press MENU, then select and decide upon WHT BAL in  with the control button (p. 96).
- (2) Select and decide upon the desired white balance mode with the control button.

HOLD :

Recording a single-colored subject or background

 **OUTDOOR :**

- Recording a sunset/sunrise, just after sunset, just before sunrise, neon signs, or fireworks
- Under a color matching fluorescent lamp

 **INDOOR :**

- Lighting condition changes quickly
- Too bright place such as photography studios
- Under sodium lamps or mercury lamps

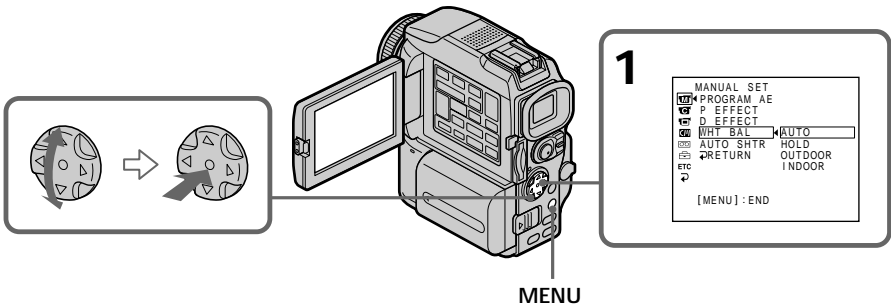

To return to the automatic white balance mode

Set WHT BAL to AUTO in the menu settings.

If the picture is being taken in a studio lit by TV lighting

We recommend that you record in the  indoor mode.

When you record under fluorescent lighting

Use the automatic white balance or hold mode.

Your camcorder may not adjust the white balance correctly in the  indoor mode.

In the automatic white balance mode

Point your camcorder at a white subject for about 10 seconds after setting the POWER switch to CAMERA to get a better adjustment when:

- You detach the battery for replacement.
- You bring your camcorder to the outdoors from the interior of a house holding the exposure, or vice versa.

In the hold white balance mode

Set the white balance to AUTO and reset to HOLD after a few seconds when:

- You change the PROGRAM AE mode.
- You bring your camcorder to the outdoors from the interior of a house, or vice versa.

Using the wide mode

You can record a 16:9 wide picture to watch on the 16:9 wide-screen TV (16:9WIDE). Black bands appear on the screen during recording in 16:9WIDE mode [a]. The picture during a playback on a normal TV [b] or on a wide-screen TV [c] is compressed in the widthwise direction. If you set the screen mode of the wide-screen TV to the full mode, you can watch pictures of normal images [d].

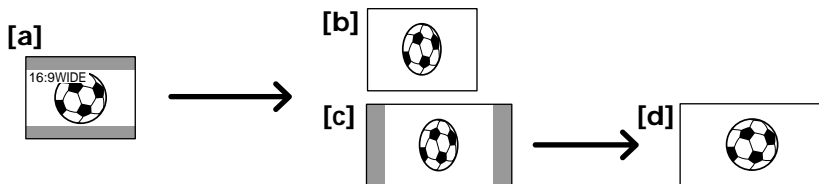

- (1) In the standby mode, press MENU, then select and decide upon 16:9WIDE in  with the control button (p. 96).
- (2) Select and decide upon ON with the control button.

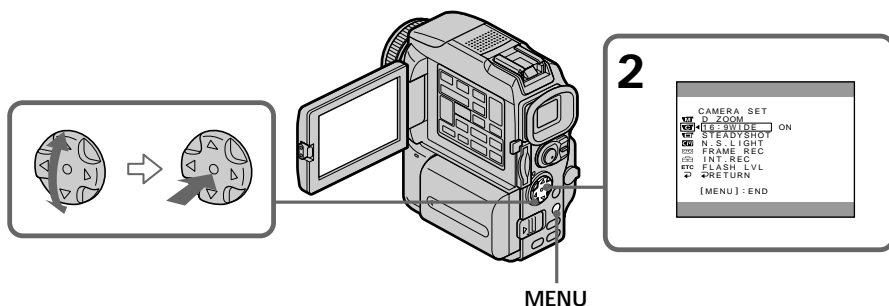

To cancel the wide mode

Set 16:9WIDE to OFF in the menu settings.

In the wide mode

You cannot select the following functions:

- OLD MOVIE
- BOUNCE

During recording

You cannot select or cancel the wide mode. When you cancel the wide mode, set your camcorder to the standby mode and then set 16:9WIDE to OFF in the menu settings.

Connection for a TV

Pictures recorded in the 16:9WIDE mode automatically appear on the TV screen at full size when:

- you connect your camcorder to a TV that is compatible with the video ID (ID-1/ID-2) system.
- you connect your camcorder to the S video jack on the TV.

ID-1 system

The ID-1 system sends aspect ratio information (16:9, 4:3, or letter box) with video signals. If you connect a TV compatible with the ID-1 system, the screen size is automatically selected.

ID-2 system

The ID-2 system sends a copyright protection signal with ID-1 signals inserted between video signals when you connect your camcorder to other equipment using an A/V connecting cable.

Using the fader function

You can fade in or out to give your recording a professional appearance.

[a] STBY REC

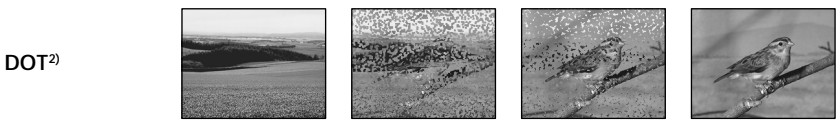
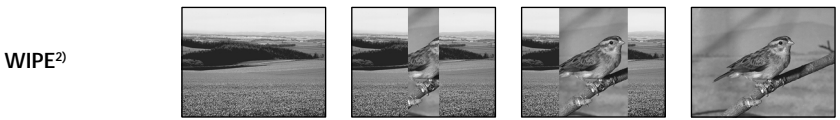
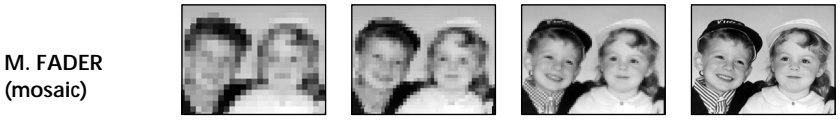

[b] STBY REC

MONOTONE

When fading in, the picture gradually changes from black-and-white to color.
 When fading out, the picture gradually changes from color to black-and-white.

¹⁾ You can use the bounce function when D ZOOM is set to OFF in the menu settings.
²⁾ Fade in only.

Using the fader function

(1) When fading in [a]

In the standby mode, press FADER until the desired fader indicator flashes.

When fading out [b]

In the recording mode, press FADER until the desired fader indicator flashes.

The indicator changes as follows:

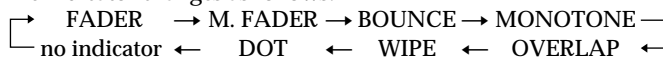

The last selected fader mode is indicated first of all.

(2) Press START/STOP. The fader indicator stops flashing.

After the fader in/out is carried out, your camcorder automatically returns to normal mode.

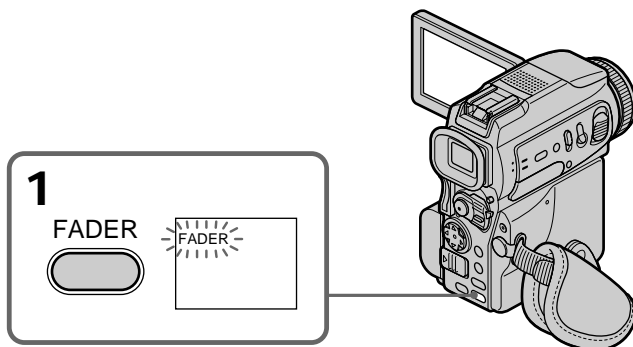

To cancel the fader function

Before pressing START/STOP, press FADER until the indicator disappears.

Note

You cannot use the following functions while using the fader function. Also, you cannot use the fader function while using the following functions:

- Digital effect
- Low lux of PROGRAM AE (Overlap, Wipe, or Dot function only) (The indicator flashes.)
- Super NightShot
- Tape photo recording
- Interval recording
- Cut recording

When you select OVERLAP, WIPE, or DOT

Your camcorder automatically stores the image recorded on a tape. As the image is being stored, the indicators flash fast, and the playback picture disappears. At this stage, the picture may not be recorded clearly, depending on the tape condition.

When you set the POWER switch to MEMORY

You cannot use the fader function.

Using the fader function

While using the bounce function, you cannot use the following functions:

- Focus
- Zoom
- Picture effect
- Exposure

Note on the bounce function

The BOUNCE indicator does not appear in the following mode or functions:

- D ZOOM is activated in the menu settings
- Wide mode
- Picture effect
- PROGRAM AE

Using special effects – Picture effect

You can digitally process images to obtain special effects like those in films or on TV.

NEG. ART [a] : The color and brightness of the picture are reversed.

SEPIA : The picture gets sepia.

B&W : The picture appears in monochrome (black-and-white).

SOLARIZE [b] : The light intensity is clearer, and the picture looks like an illustration.

SLIM [c] : The picture expands vertically.

STRETCH [d] : The picture expands horizontally.

PASTEL [e] : The contrast of the picture is emphasized, and the picture looks like an animated cartoon.

MOSAIC [f] : The picture gets mosaic-patterned.

[a]



[b]



[c]



[d]



[e]



[f]

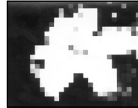

(1) Set the POWER switch to CAMERA. Press MENU, then select and decide upon P EFFECT in  with the control button (p. 96).

(2) Select and decide upon the desired picture effect mode with the control button.

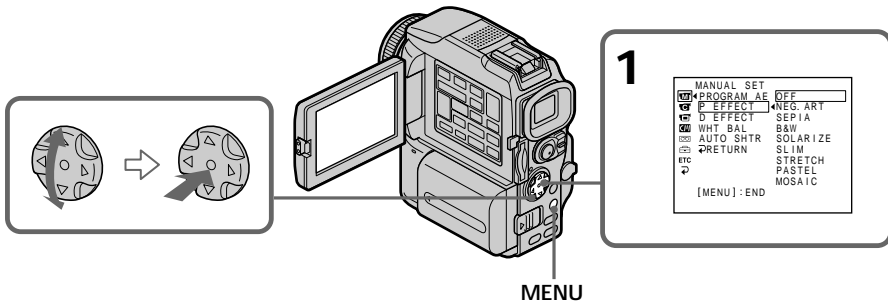

To cancel the picture effect function

Set P EFFECT to OFF in the menu settings.

While using the picture effect function

You cannot select OLD MOVIE mode with D EFFECT.

When you set the POWER switch to OFF (CHG)

The picture effect is automatically canceled.

Using special effects – Digital effect

You can add special effects to recorded pictures using the various digital functions. The sound is recorded normally.

STILL

You can record a still image so that it is superimposed on a moving picture.

FLASH (FLASH MOTION)

You can record still images successively at constant intervals.

LUMI. (LUMINANCEKEY)

You can swap a brighter area in a still picture with a moving picture.

TRAIL

You can record the picture so that an incidental image like a trail is left.

SLOW SHTR (SLOW SHUTTER)

You can slow down the shutter speed. The slow shutter mode is good for recording dark pictures more brightly.

OLD MOVIE

You can add an old movie type atmosphere to pictures. Your camcorder automatically sets the wide mode to ON and picture effect to SEPIA, and the appropriate shutter speed.

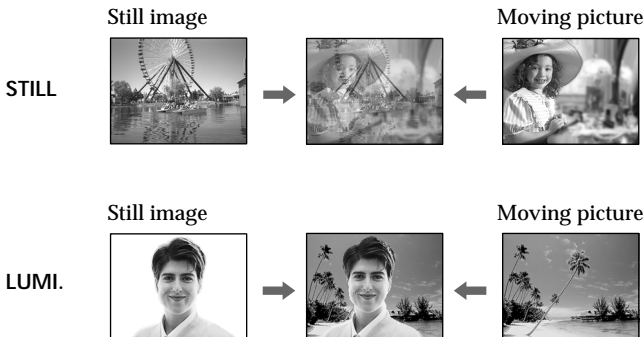

Using special effects – Digital effect

- (1) Set the POWER switch to CAMERA. Press MENU, then select and decide upon D EFFECT in  with the control button (p. 96).
- (2) Select and decide upon the desired digital effect mode with the control button. The bars appear. In the STILL or LUMI. mode, the still image that you selected and decided upon is stored in memory.
- (3) Adjust and decide upon the effect with the control button.

Items to be adjusted

STILL	The rate of the still image you want to superimpose on the moving picture
FLASH	The interval of flash motion
LUMI.	The color scheme of the area in the still image which is to be swapped with a moving picture
TRAIL	The time until the incidental image vanishes
SLOW SHTR	Shutter speed. The larger the shutter speed number, the slower the shutter speed becomes.
OLD MOVIE	No adjustment necessary

The more bars there are on the screen, the stronger the digital effect. The bars appear in the following modes: STILL, FLASH, LUMI. and TRAIL.

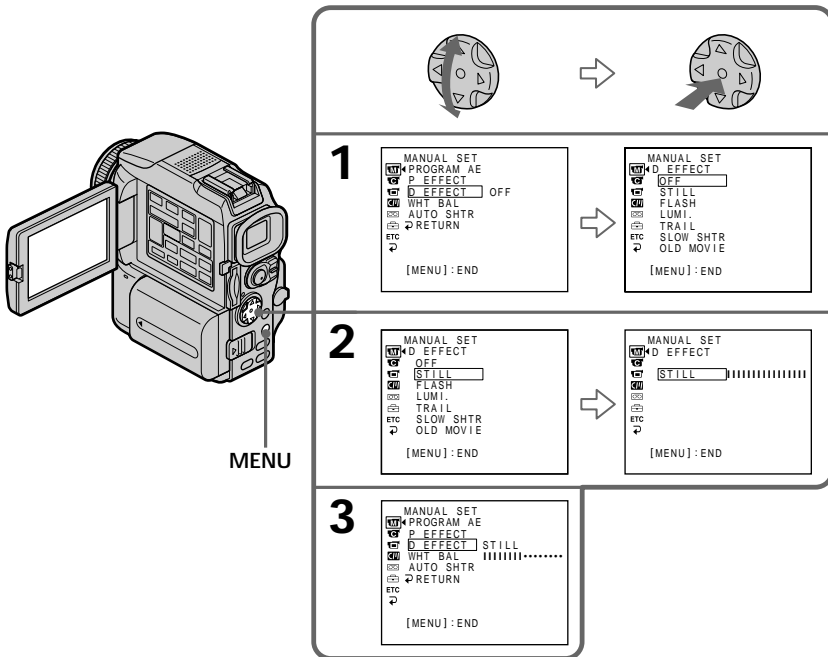

1

MANUAL SET
PROGRAM AE
P EFFECT
D EFFECT OFF
WHT BAL
AUTO SHTR
RETURN
ETC
[MENU]: END

2

MANUAL SET
D EFFECT
OFF
STILL
FLASH
LUMI.
TRAIL
SLOW SHTR
OLD MOVIE
ETC
[MENU]: END

3

MANUAL SET
PROGRAM AE
P EFFECT
D EFFECT STILL
WHT BAL
AUTO SHTR
RETURN
ETC
[MENU]: END

MENU

To cancel the digital effect function

Set D EFFECT to OFF in the menu settings.

Using special effects – Digital effect

Notes

- The following functions do not work during digital effect:
 - Fader
 - Low lux of PROGRAM AE (The indicator flashes.)
 - Tape photo recording
 - Super NightShot
- The PROGRAM AE function does not work in the slow shutter mode.
- The following functions do not work in the old movie mode:
 - Wide mode
 - Picture effect
 - PROGRAM AE

When you set the POWER switch to OFF (CHG)

The digital effect is automatically canceled.

When recording in the slow shutter mode

Auto focus may not be effective. Focus manually using a tripod.

Shutter speed

Shutter speed number	Shutter speed
SLOW SHTR 1	1/30
SLOW SHTR 2	1/15
SLOW SHTR 3	1/8
SLOW SHTR 4	1/4

Using the PROGRAM AE function

You can select PROGRAM AE (Auto Exposure) mode to suit your specific shooting requirements.

Spotlight

This mode prevents peoples' faces, for example, from appearing excessively white when shooting subjects lit by strong light in the theater.

Soft portrait

This mode brings out the subject while creating a soft background for subjects such as people or flowers.

Sports lesson

This mode minimizes shake on fast-moving subjects such as in tennis or golf.

Beach & ski

This mode prevents peoples' faces from appearing dark in strong light or reflected light, such as at a beach in midsummer or on a ski slope.

Sunset & moon

This mode allows you to maintain atmosphere when you are recording sunsets, general night views, fireworks displays and neon signs.

Landscape

This mode is for when you are recording distant subjects such as mountains, and prevents your camcorder from focusing on glass or metal mesh in windows when you are recording a subject behind glass or a screen.

Low lux

This mode makes subjects brighter in insufficient light.



Using the PROGRAM AE function

- (1) Set the POWER switch to CAMERA or MEMORY. Press MENU, then select and decide upon PROGRAM AE in  with the control button (p. 96).
- (2) Select and decide upon the desired PROGRAM AE mode with the control button.

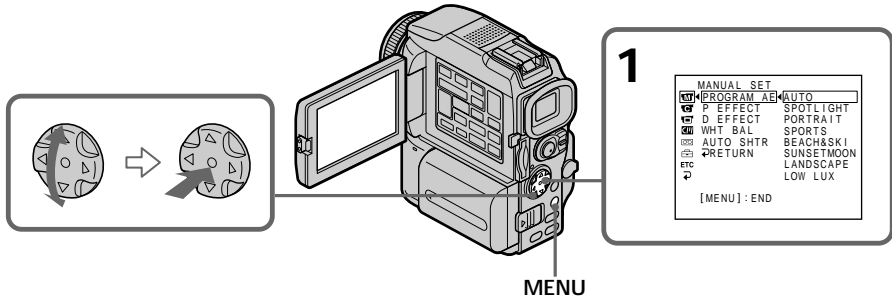

To cancel the PROGRAM AE function

Select PROGRAM AE to AUTO in the menu settings.

Notes

- Because your camcorder is set to focus only on subjects in the middle to far distance, you cannot take close-ups in the following modes:
 - Spotlight
 - Sports lesson
 - Beach & ski
- Your camcorder is set to focus only on distant subjects in the following modes:
 - Sunset & moon
 - Landscape
- The following functions do not work in the PROGRAM AE mode:
 - Slow shutter
 - Old movie
 - Bounce
- The following functions do not work in the low lux mode:
 - Digital effect
 - Overlap
 - Wipe
 - Dot
 - Recording with the flash
- When you set the POWER switch to MEMORY, the following modes do not work (The indicator flashes.):
 - Low lux
 - Sports lesson
- The PROGRAM AE function does not work in the following cases. (The indicator flashes.)
 - To set NIGHTSHOT to ON
 - To record images on a “Memory Stick” using the MEMORY MIX function.

Using the PROGRAM AE function

While WHT BAL is set to AUTO in the menu settings

The white balance is adjusted even if the PROGRAM AE function is selected.

Even if the PROGRAM AE function is selected

You can adjust the exposure.

If you are recording under a discharge tube such as a fluorescent lamp, sodium lamp or mercury lamp

Flickering or changes in color may occur in the following modes. If this happens, turn the PROGRAM AE function off.

- Soft portrait
- Sports lesson

Adjusting the exposure manually

You can manually adjust and set the exposure. Normally exposure is automatically adjusted. Adjust the exposure manually in the following cases:

- The subject is backlit
- Bright subject and dark background
- To record dark pictures (e.g. night scenes) faithfully

- (1) Set the POWER switch to CAMERA or MEMORY, press EXPOSURE. The exposure indicator appears.
- (2) Push ◀/▶ on the control button to adjust the brightness.

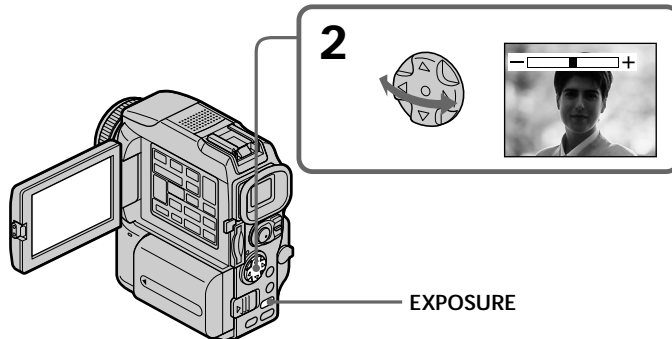

To return to the automatic exposure mode

Press EXPOSURE.

Note

When you adjust the exposure manually, the backlight function does not work.

Your camcorder automatically returns to the automatic exposure mode:

- If you change the PROGRAM AE mode.
- If you slide NIGHTSHOT to ON.

Focusing manually

You can gain better results by manually adjusting the focus in the following cases. Normally, focus is automatically adjusted:

- The autofocus mode is not effective when shooting:
 - subjects through glass coated with water droplets
 - horizontal stripes
 - subjects with little contrast with backgrounds such as walls and sky
- When you want to change the focus from a subject in the foreground to a subject in the background.
- Shooting a stationary subject when using a tripod.

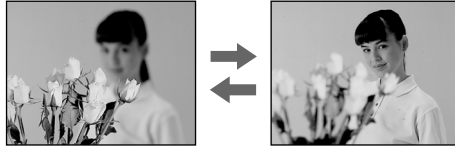

- (1) Set the POWER switch to CAMERA or MEMORY, press FOCUS lightly. The  indicator appears.
- (2) Turn the focus ring to sharpen focus.

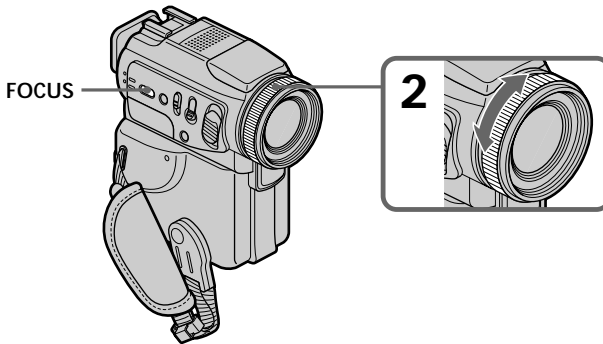

To return to the autofocus mode

Press FOCUS lightly to turn off the indicator.

To record distant subjects

When you press FOCUS down firmly, the lens focuses on and  indicator appears. When you release FOCUS, your camcorder returns to the manual focus mode. Use this mode when your camcorder focuses on near objects even though you are trying to shoot a distant object.

Focusing manually



To focus precisely

It is easier to focus on the subject if you adjust the zoom to shoot at the “W” (wide-angle) after focusing at the “T” (telephoto) position.

When you shoot close to the subject

Focus at the end of the “W” (wide-angle) position.

changes as follows:

-  when recording a distant subject
-  when the subject is too close to focus on

Focal distance information is displayed for about three seconds on the screen in the following cases:

- When switching the focus adjustment mode from autofocus to manual
- When turning the focus ring

Focal distance information

- This information aids focusing if it is not easy to focus on the subject, for example, when recording in the dark. Use this information as a rough guide to get a sharp focus.
- You cannot get correct information if you have attached a conversion lens to your camcorder.

Interval recording

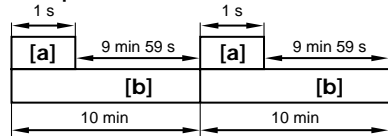

You can make a time-lapse recording by setting the camcorder to automatically record and standby sequentially. You can achieve an excellent recording for flowering, emergence, etc., with this function.

Example



[a] REC TIME

[b] INTERVAL

- (1) In the standby mode, press MENU, then select and decide upon INT. REC in  with the control button (p. 96).
- (2) Select and decide upon SET with the control button.
- (3) Set INTERVAL and REC TIME.
 - ① Select and decide upon INTERVAL with the control button.
 - ② Select and decide upon the desired interval time with the control button.
The time: 30SEC ↔ 1MIN ↔ 5MIN ↔ 10MIN
 - ③ Select and decide upon REC TIME with the control button.
 - ④ Select and decide upon the desired recording time with the control button.
The time: 0.5SEC ↔ 1SEC ↔ 1.5SEC ↔ 2SEC
 - ⑤ Select and decide upon  RETURN with the control button.
- (4) Select and decide upon ON with the control button.
- (5) Press MENU to erase the menu display. The INTERVAL indicator flashes.
- (6) Press START/STOP to start interval recording. The INTERVAL indicator lights up.

Interval recording

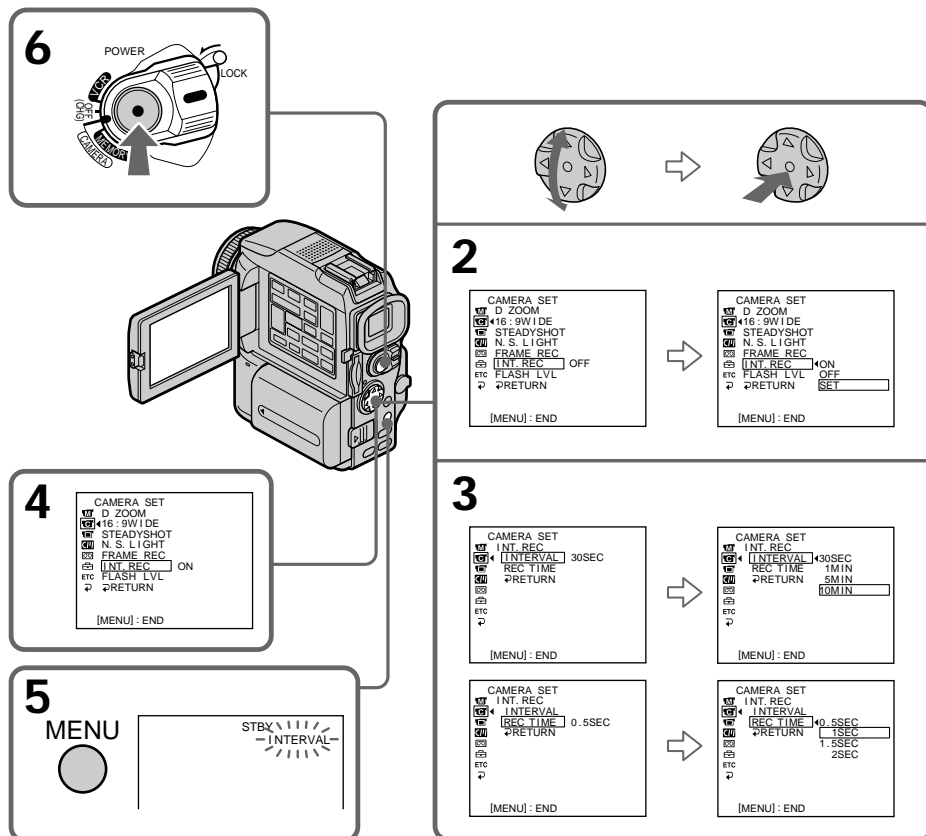

To cancel the interval recording

Perform either of the following:

- Set INT. REC to OFF in the menu settings.
- Set the POWER switch to other than CAMERA.

To perform normal recording during the interval recording

You can perform normal recording only once during INTERVAL.

Press START/STOP. The INTERVAL indicator flashes, and normal recording starts. To stop normal recording, press START/STOP again.

On recording time

There may be a discrepancy in recording time of up to +/- six frames from the selected time.

Frame by frame recording – Cut recording

You can make a recording with a stop-motion animated effect using cut recording. To create this effect, alternately move the subject a little and make a cut recording. We recommend that you use a tripod, and operate the camcorder using the Remote Commander after step 4.

- (1) In the standby mode, press MENU, then select and decide upon FRAME REC in  with the control button (p. 96).
- (2) Select and decide upon ON with the control button.
- (3) Press MENU to erase the menu display. The FRAME REC indicator lights up.
- (4) Press START/STOP to start cut recording. The camcorder makes a recording for about six frames, and returns to recording standby.
- (5) Move the subject, and repeat step 4.

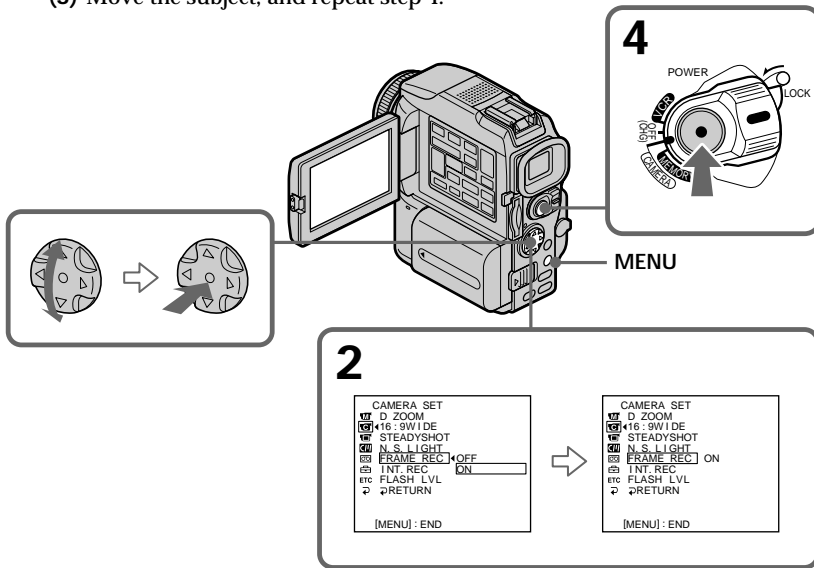

To cancel the cut recording

Perform either of the following:

- Set FRAME REC to OFF in the menu settings.
- Set the POWER switch to other than CAMERA.

Note

The proper remaining tape time is not indicated if you use this function continuously.

When using the cut recording function

The last recorded cut is longer than other cuts.

Playing back a tape with picture effects

During playback, you can process a scene using the picture effect functions: NEG. ART, SEPIA, B&W and SOLARIZE.

- (1) In the playback or playback pause mode, press MENU, then select and decide upon P EFFECT in  with the control button (p. 96).
- (2) Select and decide upon the desired mode with the control button.
For details of each picture effect function, see page 45.

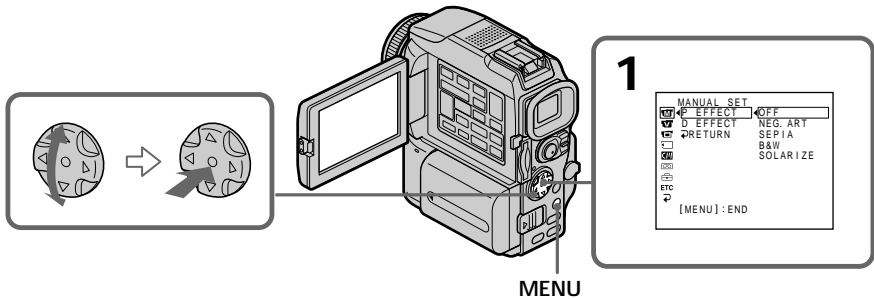

To cancel the picture effect function

Set P EFFECT to OFF in the menu settings.

Notes

- You cannot process externally input scenes using the picture effect function.
- You cannot record images on a tape on your camcorder when you have processed the image using the picture effect function. However, you can record images on a “Memory Stick” (p. 118, 128), or on a VCR using your camcorder as a player.

Pictures processed by the picture effect function

Pictures processed by the picture effect function are not output through the  DV jack.

When you set the POWER switch to OFF (CHG) or stop playing back
The picture effect function is automatically canceled.

Playing back a tape with digital effects

During playback, you can process a scene using the digital effect functions: STILL, FLASH, LUMI. and TRAIL.

- (1) In the playback or playback pause mode, press MENU, then select and decide upon D EFFECT in  with the control button (p. 96).
- (2) Select and decide upon the desired mode with the control button. The bars appear. In the STILL or LUMI. mode, the picture is captured and is stored in memory as a still image.
- (3) Press ◀/▶ on the control button to adjust the effect with the control button. For details of each digital effect function, see page 46.

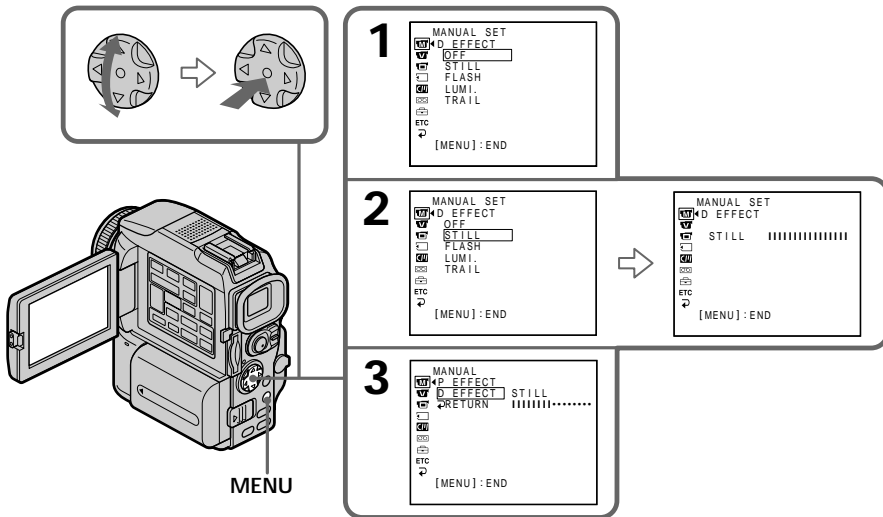

To cancel the digital effect function

Set D EFFECT to OFF in the menu settings.

Notes

- You cannot process externally input scenes using the digital effect function.
- You cannot record images on a tape on your camcorder when you have processed the image using the digital effect function. However, you can record images on a “Memory Stick” (p. 118, 128), or on a VCR using your camcorder as a player.

Pictures processed by the digital effect function

Pictures processed by the digital effect function are not output through the  DV jack.

When you set the POWER switch to OFF (CHG) or stop playing back

The digital effect function is automatically canceled.

Enlarging images recorded on tapes – Tape PB ZOOM

You can enlarge playback images recorded on tapes. Besides the operation described here, your camcorder can enlarge still images recorded on “Memory Stick”s (p. 148).

- (1) In the playback or playback pause mode, press PB ZOOM on your camcorder.
The center of the image is enlarged to twice its size.
- (2) Press the control button to move the image.
The image moves in the same direction as the control button setting.
- (3) Adjust the zoom ratio by the power zoom lever.

You can enlarge the image from 1.1 times up to five times its size.

W: Decreases the zoom ratio.

T: Increases the zoom ratio.

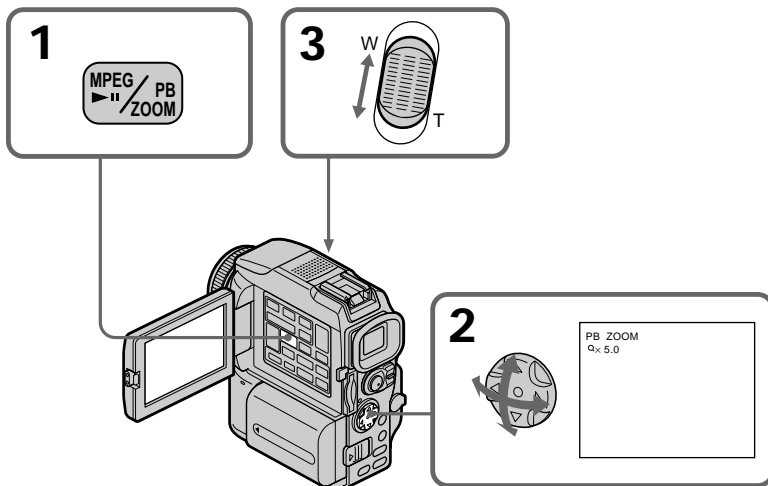

To cancel the PB ZOOM function

Press PB ZOOM.

Notes

- You cannot process externally input scenes using the PB ZOOM function with your camcorder.
- You cannot record images on a tape on your camcorder when you have processed the image using the tape PB ZOOM function. However, you can record images on a VCR using your camcorder as a player.
- You cannot record moving pictures on a “Memory Stick” on your camcorder when you have processed the picture using the tape PB ZOOM function.

The PB ZOOM function is automatically canceled when you operate the following functions:

- Set the POWER switch to OFF (CHG).
- Stop playback.
- Display the menu settings.

Images in the PB ZOOM

Images in the PB ZOOM mode are not output through the  DV jack.

Quickly locating a scene using the zero set memory function

Your camcorder goes forward or backward to automatically stop at a desired scene having a tape counter value of "0:00:00". Use the Remote Commander for this operation.

- (1) In the playback mode, press DISPLAY.
- (2) Press ZERO SET MEMORY at the point you want to locate later. The tape counter shows "0:00:00" and the ZERO SET MEMORY indicator flashes.
- (3) Press ■ when you want to stop playback.
- (4) Press ◀◀ to rewind the tape to the tape counter's zero point. The tape stops automatically when the tape counter reaches approximately zero. The ZERO SET MEMORY indicator disappears and the time code appears.
- (5) Press ▶▶. Playback starts from the counter's zero point.

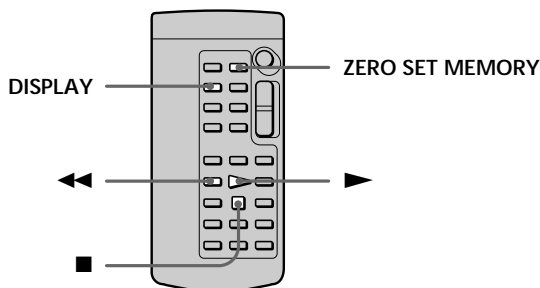

Notes

- When you press ZERO SET MEMORY before rewinding the tape, the zero set memory function will be canceled.
- There may be a discrepancy of several seconds from the time code.

If a tape has a blank portion in the recorded portions

The zero set memory function may not work correctly.

Searching the boundaries of recorded tape by title – Title search

CM
only

If you use a tape with cassette memory, you can search for the boundaries of recorded tape by title. Use the Remote Commander for this operation.



Before operation

Set CM SEARCH in  to ON in the menu settings. (The default setting is ON.)

- (1) Set the POWER switch to VCR.
- (2) Press SEARCH MODE on the Remote Commander repeatedly, until the TITLE SEARCH indicator appears.

The indicator changes as follows:



- (3) Press  or  on the Remote Commander to select the title for playback. Your camcorder automatically starts playback of the scene having the title that you selected.

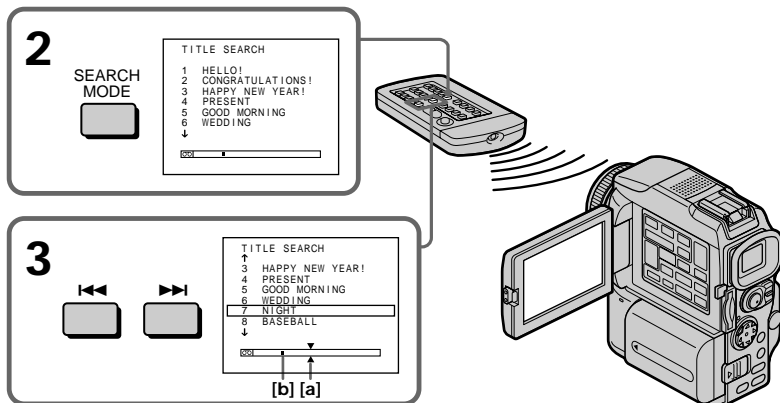

[a] Actual point you are trying to search for

[b] Present point on the tape

To stop searching

Press .

If you use a tape without cassette memory

You cannot superimpose or search a title.

If a tape has a blank portion between recorded portions

The title search function may not work correctly.

To superimpose a title

See page 90.

Searching a recording by date

- Date search

You can automatically search for the point where the recording date changes and start playback from that point (**Date search**). Use a tape with cassette memory for convenience. Use the Remote Commander for this operation. Use this function to check where recording dates change or to edit the tape at each recording date.

Searching for the date by using cassette memory



Before operation

- You can use this function only when playing back a tape with cassette memory.
- Set CM SEARCH in  to ON in the menu settings. (The default setting is ON).

- (1) Set the POWER switch to VCR.
- (2) Press SEARCH MODE on the Remote Commander repeatedly, until the DATE SEARCH indicator appears.

The indicator changes as follows:



- (3) Press  or  on the Remote Commander to select the date for playback. Your camcorder automatically starts playback at the beginning of the selected date.

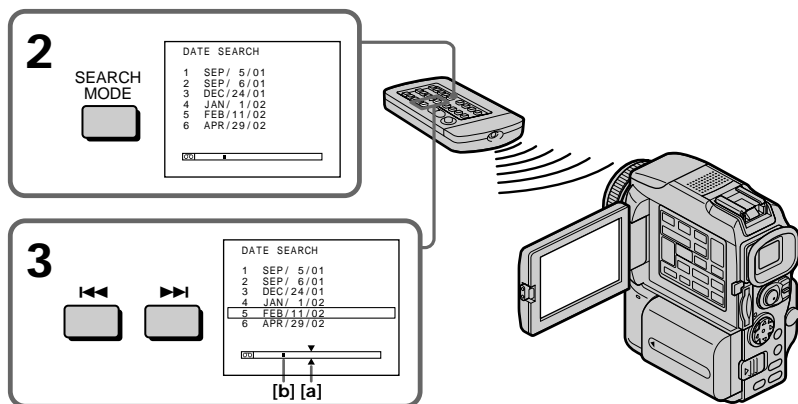

- [a] Actual point you are trying to search for
[b] Present point on the tape

To stop searching

Press .

Searching a recording by date - Date search

Note

If one day's recording is less than two minutes, your camcorder may not accurately find the point where the recording date changes.







If a tape has a blank portion between recorded portions

The date search function may not work correctly.

Cassette memory

The tape cassette memory can hold six recording date data. If you search the date among seven or more data, see "Searching for the date without using cassette memory" below.

Searching for the date without using cassette memory

- (1) Set the POWER switch to VCR.
- (2) Press MENU, then select and decide upon CM SEARCH in  to OFF with the control button (p. 96).
- (3) Press SEARCH MODE on the Remote Commander repeatedly until the DATE SEARCH indicator appears.
The indicator changes as follows:

- (4) Press  on the Remote Commander to search for the previous date or press  on the Remote Commander to search for the next date. Your camcorder automatically starts playback at the point where the date changes. Each time you press  or , your camcorder searches for the previous or next date.

To stop searching

Press .

Searching for a photo

- Photo search/Photo scan

You can search for a still image you have recorded on a tape (photo search). You can also search for still images one after another and display each image for five seconds automatically regardless of cassette memory (photo scan). Use the Remote Commander for these operations.

Use this function to check or edit still images.

Searching for a photo by using cassette memory



Before operation

- You can use this function only when playing back a tape with cassette memory.
- Set CM SEARCH in  to ON in the menu settings. (The default setting is ON.)

- (1) Set the POWER switch to VCR.
- (2) Press SEARCH MODE on the Remote Commander repeatedly, until the PHOTO SEARCH indicator appears.

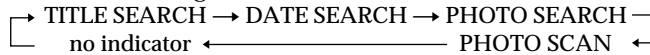
The indicator changes as follows:



- (3) Press  or  on the Remote Commander to select the date for playback. Your camcorder automatically starts playback of the photo having the date that you selected.

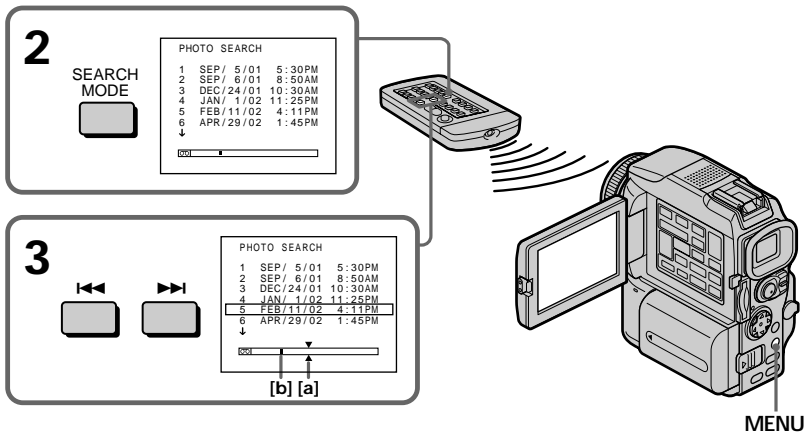

[a] Actual point you are trying to search for





[b] Present point on the tape

To stop searching

Press .

Searching for a photo – Photo search/Photo scan



Searching for a photo without using cassette memory

- (1) Set the POWER switch to VCR.
- (2) Press MENU, then select and decide upon CM SEARCH in  to OFF with the control button (p. 96).
- (3) Press SEARCH MODE on the Remote Commander repeatedly until the PHOTO SEARCH indicator appears.
The indicator changes as follows:
↳ DATE SEARCH → PHOTO SEARCH → PHOTO SCAN → no indicator ↵
- (4) Press  or  on the Remote Commander to select the photo for playback.
Each time you press  or , your camcorder searches for the previous or next photo.
Your camcorder automatically starts playback of the photo.

To stop searching

Press .

Scanning photo

- (1) Set the POWER switch to VCR.
- (2) Press SEARCH MODE on the Remote Commander repeatedly until the PHOTO SCAN indicator appears.
The indicator changes as follows:
↳ DATE SEARCH → PHOTO SEARCH → PHOTO SCAN → no indicator ↵
- (3) Press  or  on the Remote Commander.
Each photo is played back for about five seconds automatically.

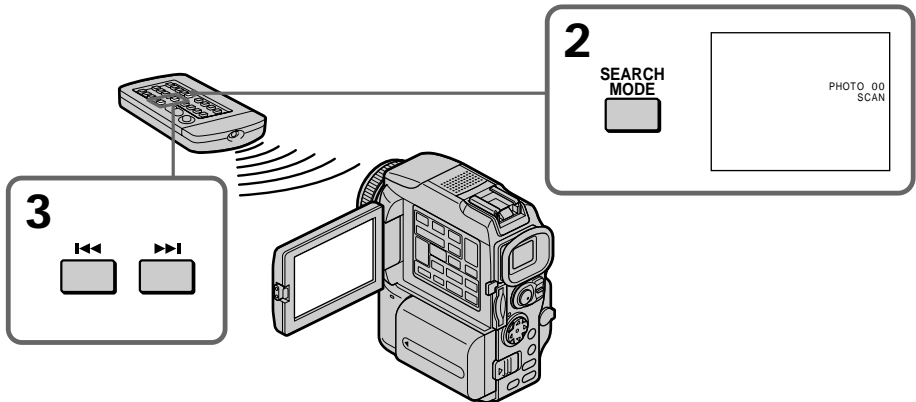

To stop scanning

Press .

If a tape has a blank portion between recorded portions
The photo search/photo scan function may not work correctly.

The available number of photos that can be searched using the cassette memory
The available number is up to 12 photos. However, you can search 13 photos or more
using the scanning photo function.

Dubbing a tape

Using the A/V connecting cable

You can dub or edit on the VCR connected to your camcorder using your camcorder as a player.

Connect your camcorder to the VCR using the A/V connecting cable supplied with your camcorder.

Before operation

- Set DISPLAY to LCD in the menu settings. (The default setting is LCD.)
- Press the following buttons to make the indicator disappear so that they will not be superimposed on the edited tape:
 - DISPLAY
 - DATA CODE on the Remote Commander
 - SEARCH MODE on the Remote Commander

- (1) Insert a blank tape (or a tape you want to record over) into the VCR, and insert the recorded tape into your camcorder.
- (2) Prepare the VCR for recording, then set the input selector to LINE. Connect the A/V connecting cable to AUDIO/VIDEO jack. Refer to the operating instructions of the VCR.
- (3) Set the POWER switch to VCR on your camcorder.
- (4) Play back the recorded tape on your camcorder.
- (5) Start recording on the VCR. Refer to the operating instructions of your VCR.

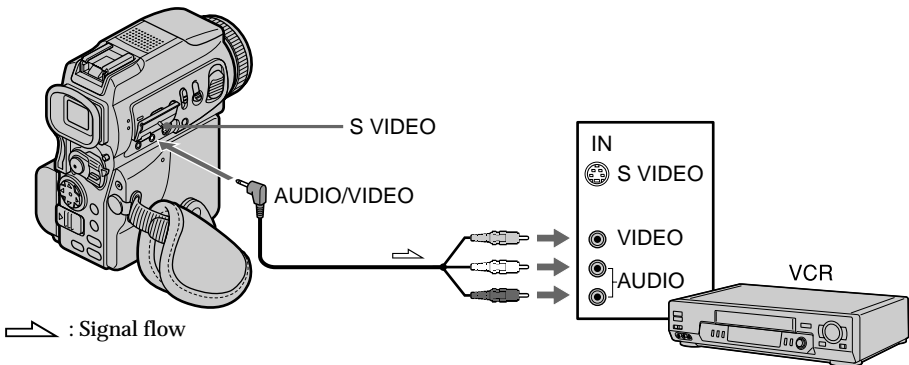

When you have finished dubbing a tape

Press **■** on both your camcorder and the VCR.

You can edit on VCRs that support the following systems:

- 8 mm, Hi8, Hi8, VHS, VHS, S-VHS, S-VHS, VHSC, VHSC, S-VHSC, S-VHSC,
- Betamax, ED Betamax, Mini DV, DV, Digital8

If your VCR is a monaural type

Connect the yellow plug of the A/V connecting cable to the video input jack and the white or the red plug to the audio input jack on the VCR or the TV. When the white plug is connected, the left channel audio is output, and when the red plug is connected, the right channel audio is output.

Dubbing a tape

If your VCR has an S video jack

Pictures can be reproduced more faithfully by using an S video cable (optional). With this connection, you do not need to connect the yellow (video) plug of the A/V connecting cable.

Connect an S video cable (optional) to the S video jacks of both your camcorder and the VCR.

This connection produces higher quality DV format pictures.

Using the i.LINK cable (DV connecting cable)

Simply connect the i.LINK cable (DV connecting cable) (optional) to the DV jack of your camcorder and to DV IN of the DV products. With a digital-to-digital connection, video and audio signals are transmitted in digital form for high-quality editing. You cannot dub the titles, display indicators or the contents of cassette memory or letters on the "Memory Stick" index screen.

Set the input selector on the VCR to the DV input position if the VCR is equipped with the input selector.

- (1) Insert a blank tape (or a tape you want to record over) into the VCR, and insert the recorded tape into your camcorder.
- (2) Prepare the VCR for recording.
Set the input selector to LINE. Refer to the operating instructions of the VCR.
- (3) Set the POWER switch to VCR on your camcorder.
- (4) Play back the recorded tape on your camcorder.
- (5) Start recording on the VCR. Refer to the operating instructions of the VCR.

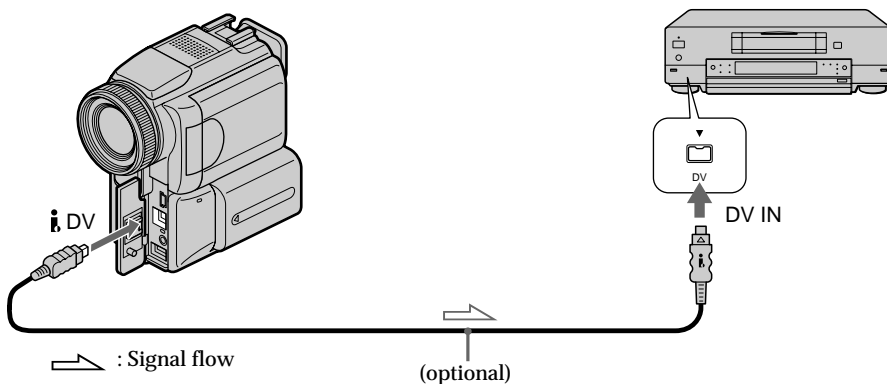

When you have finished dubbing a tape

Press ■ on both your camcorder and the VCR.

You can connect one VCR only using the i.LINK cable (DV connecting cable)

See page 169 for more information about i.LINK.

Pictures processed by the picture effect, the digital effect or PB ZOOM function

Pictures processed by the picture effect, the digital effect or PB ZOOM function are not output through the DV jack.

If you record a playback pause picture with the DV jack

The recorded picture becomes rough. And when you play back the picture using the other video equipment, the picture may jitter.

Dubbing only desired scenes

- Digital program editing (on tapes)

You can duplicate selected scenes (programs) for editing onto a tape without operating the VCR.

Scenes can be selected by frame. You can set up to 20 programs.

Your camcorder can dub on "Memory Stick"s. See p. 132 for more information.

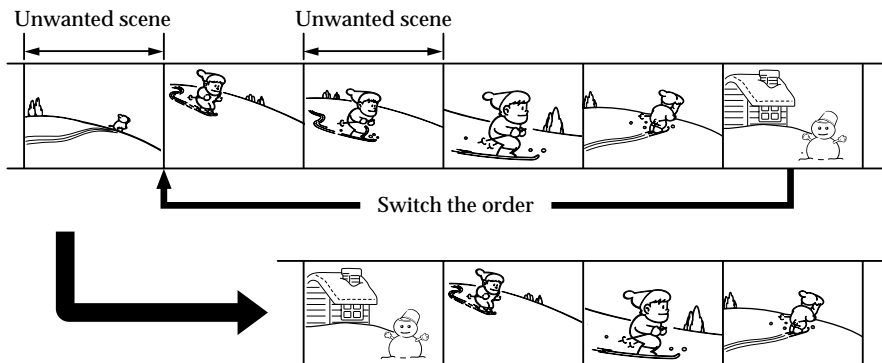

Before operating the Digital program editing on tapes recorded on other equipment

Step 1 Connecting the VCR (p. 69).

Step 2 Setting the VCR for operation (p. 70, 74).

Step 3 Adjusting the synchronization of the VCR (p. 75).

When you dub using the same VCR again, you can skip steps 2 and 3.

Using the Digital program editing function on tapes recorded on other equipment

Operation 1 Making the program (p. 77).

Operation 2 Performing the program (dubbing a tape) (p. 79).

Notes

- When you connect with an i.LINK cable (DV connecting cable), you may not be able to operate the dubbing function correctly, depending on the VCR. Set CONTROL to IR in the menu settings of your camcorder.
- When editing digital video on tapes, the operation signals cannot be sent with LANC.

Step 1: Connecting the VCR

You can connect both an A/V connecting cable and an i.LINK cable (DV connecting cable).

When you use the A/V connecting cable, connect the devices as illustrated on page 67.

When you use an i.LINK cable (DV connecting cable), connect the devices as illustrated on page 68.

If you connect using an i.LINK cable (DV connecting cable)

With digital-to-digital connection, video and audio signals are transmitted in digital form for high-quality editing.

Dubbing only desired scenes – Digital program editing (on tapes)

Step 2: Setting the VCR to operate with the A/V connecting cable

To edit using the VCR, send the control signal by infrared rays to the remote sensor on the VCR.

When you connect using an A/V connecting cable, follow the procedure below, (1) to (4), to send the control signal correctly.

(1) Set the IR SETUP code

- ① Set the POWER switch to VCR on your camcorder.
- ② Turn the power of the connected VCR on, then set the input selector to LINE. When you connect a video camera recorder, set its power switch to VCR/VTR.
- ③ Press MENU, then select and decide upon VIDEO EDIT in **[ETC]** with the control button (p. 96).
- ④ Select and decide upon TAPE with the control button.
- ⑤ Select and decide upon EDIT SET with the control button.
- ⑥ Select and decide upon CONTROL with the control button.
- ⑦ Select and decide upon IR with the control button.
- ⑧ Select and decide upon IR SETUP, then select and decide upon IR SETUP code of your VCR with the control button.

Check the code in “About the IR SETUP code.” (p. 71)

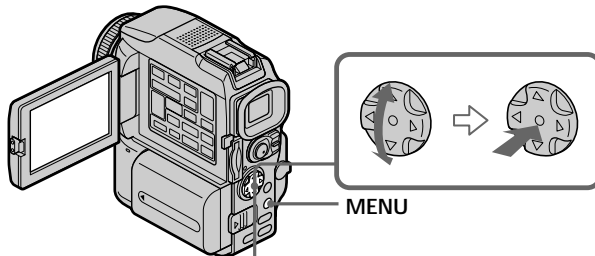

<p>3</p> <pre> OTHERS DATA CODE BEEP COMMANDER DISPLAY [VIDEO EDIT] READY [RETURN] [ETC] [MENU] : END </pre> <p>→</p> <pre> OTHERS DATA CODE BEEP COMMANDER DISPLAY [VIDEO EDIT] RETURN [RETURN] TAPE [ETC] MEMORY [MENU] : END </pre>	<p>5</p> <pre> VIDEO EDIT 0:08:55:06 MARK UNDO ERASE ALL START [EDIT SET] IR TOTAL 0:00:00:00 SCENE 0 [MENU] : END </pre>
<p>4</p> <pre> OTHERS DATA CODE BEEP COMMANDER DISPLAY [VIDEO EDIT] RETURN [RETURN] TAPE [ETC] MEMORY [MENU] : END </pre> <p>→</p> <pre> VIDEO EDIT 0:08:55:06 [MARK] 1 IN UNDO ERASE ALL START EDIT SET TOTAL 0:00:00:00 SCENE 0 [MENU] : END </pre>	<p>6</p> <pre> VIDEO EDIT 0:08:55:06 EDIT SET CONTROL [IR] ADJ TEST "CUT-IN" :LNK "CUT-OUT" IR SETUP PAUSEMODE IR TEST [RETURN] [MENU] : END </pre>
<p>8</p> <pre> VIDEO EDIT 0:08:55:06 EDIT SET CONTROL ADJ TEST "CUT-IN" "CUT-OUT" [IR SETUP] 1 PAUSEMODE IR TEST [RETURN] [MENU] : END </pre>	

Dubbing only desired scenes – Digital program editing (on tapes)

About the IR SETUP code

The IR SETUP code is stored in the memory of your camcorder. Be sure to set the correct code, depending on your VCR. The default setting is code number 3.

Brand	IR SETUP code
Sony	1, 2, 3, 4, 5, 6
Admiral (M. Wards)	89
Aiwa	80
Audio Dynamic	21, 35
Bell&Howell (M. Wards)	36
Brocsonic	70, 82
Canon	77, 78, 97
Citizen	47
Craig	47, 73
Curtis Mathis	8, 77, 80
Daewoo	26, 40, 77
DBX	21, 33, 35
Dimensia	8
Emerson	26, 48, 59, 70, 81, 82
Fisher	36, 37, 44, 45
Funai	80
General Electric	8, 32*, 77, 87, 94*
Goldstar	47
Hitachi	8, 42, 78
Instant Replay	77, 78
JC Penny	8, 21, 33, 35, 36, 42, 77
JVC	12, 13, 14, 21, 33, 35
Kenwood	21, 33, 35, 47
LXI (Sears)	36, 37, 42, 44, 45, 47, 80
Magnavox	77, 78, 83
Marantz	21, 33, 35
Marta	47
Memorex	37, 77
Minolta	8, 42
Mitsubishi/MGA	22, 23, 24, 28

Brand	IR SETUP code
Multitech	23, 32, 80
NEC	21, 33, 35
Olympic	77, 78
Panasonic	16, 17, 77, 78, 96
Pentax	8, 42
Philco	77, 78
Philips	77, 78, 83
Pioneer	78
Quasar	16, 17, 77, 78
RCA/PROSCAN	7, 8, 16, 40, 41, 42, 77, 78*, 83, 101
Realistic	36, 77
Sansui	21
Singer	73
Samsung	24*, 32, 32*, 41, 94, 94*
Sanyo	36, 37
Scott	22, 23, 24, 28, 32, 37, 40, 41
Sharp	88, 89
Shintom	73
Signature 2000 (M. Wards)	80, 89
Sylvania	77, 78, 80, 83
Symphonic	80
Tashiro	47
Tatung	21, 33, 35
Teac	21, 33, 35, 80
Technics	77, 78
Toshiba	7, 40
Wards	37, 47, 88, 89, 95
Yamaha	21, 33, 35, 36
Zenith	95

* TV/VCR component

Note on IR SETUP code

Digital program editing is not possible if the VCR does not support IR SETUP codes.

Dubbing only desired scenes – Digital program editing (on tapes)

(2) Setting the modes to cancel the recording pause on the VCR

Select and decide upon PAUSEMODE with the control button, then select and decide upon the mode to cancel recording pause on the VCR with the control button. Refer to the operating instructions of your VCR.

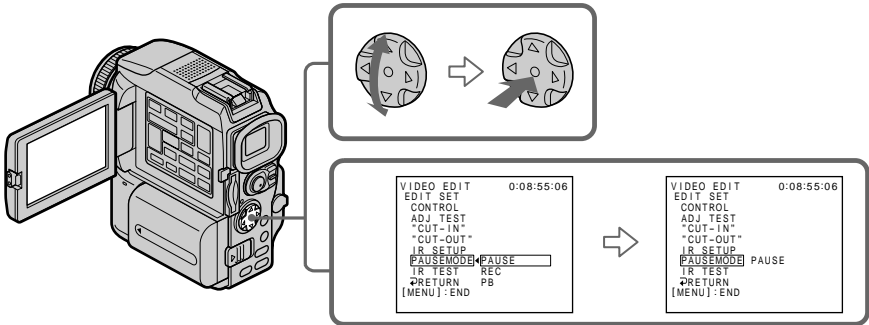

The buttons to cancel recording pause on the VCR

The buttons vary depending on your VCR. To cancel recording pause:

- Select PAUSE if the button to cancel recording pause is **II**.
- Select REC if the button to cancel recording pause is **●**.
- Select PB if the button to cancel recording pause is **▶▶**.

(3) Setting your camcorder and the VCR to face each other

Locate the infrared rays emitter of your camcorder and face it towards the remote sensor of the VCR.

Set the devices about 30 cm (12 in.) apart, and remove any obstacles between the devices.

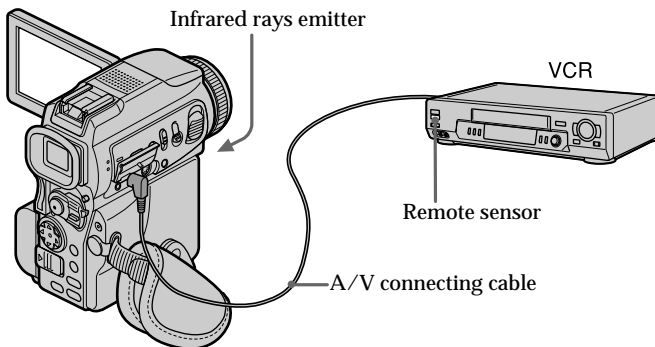

Dubbing only desired scenes – Digital program editing (on tapes)

(4) Confirming the VCR operation

- ① Insert a recordable tape into the VCR, then set to recording pause.
- ② Select and decide upon IR TEST with the control button.
- ③ Select and decide upon EXECUTE with the control button.

If the VCR starts recording, the setting is correct.

When recording is finished, the indicator changes to COMPLETE.

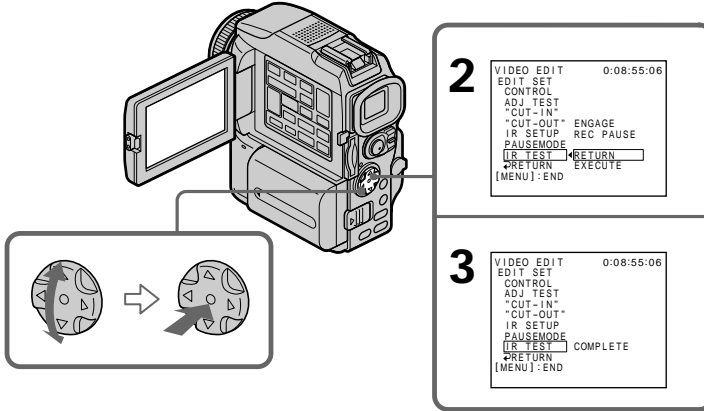

When the VCR does not operate correctly

- After checking the code in "About the IR SETUP code", set the IR SETUP or the PAUSEMODE again.
- Place your camcorder at least 30 cm (12 in.) away from the VCR.
- Refer to the operating instructions of your VCR.

Dubbing only desired scenes – Digital program editing (on tapes)

Step 2: Setting the VCR to operate with the i.LINK cable (DV connecting cable)

When you connect using i.LINK cable (DV connecting cable) (optional), follow the procedure below.

- (1) Set the POWER switch to VCR on your camcorder.
- (2) Turn the power of the connected VCR on, then set the input selector to DV input. When you connect a digital video camera recorder, set its power switch to VCR/VTR.
- (3) Press MENU, then select and decide upon VIDEO EDIT in **[ETC]** with the control button (p. 96).
- (4) Select and decide upon TAPE with the control button.
- (5) Select and decide upon EDIT SET with the control button.
- (6) Select and decide upon CONTROL with the control button.
- (7) Select and decide upon i.LINK with the control button.

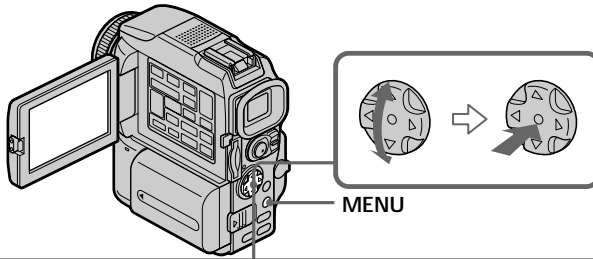

<p>3</p> <div style="border: 1px solid black; padding: 5px; margin-bottom: 5px;"> <p>OTHERS [VCR] DATA CODE [VCR] BEEP [VCR] COMMANDER [DISP] DISPLAY [MEM] VIDEO EDIT READY [RETN] RETURN [ETC] ETC [MENU] END</p> </div> <div style="text-align: center; font-size: 2em;">➔</div> <div style="border: 1px solid black; padding: 5px;"> <p>OTHERS [VCR] DATA CODE [VCR] BEEP [VCR] COMMANDER [DISP] DISPLAY [MEM] VIDEO EDIT RETURN [RETN] RETURN TAPE MEMORY [ETC] ETC [MENU] END</p> </div>	<p>5</p> <div style="border: 1px solid black; padding: 5px;"> <p>VIDEO EDIT 0:08:55:06 MARK UNDO ERASE ALL START EDIT SET IR TOTAL 0:00:00:00 SCENE 0 [RETN] RETURN [MENU] END</p> </div>
<p>4</p> <div style="border: 1px solid black; padding: 5px; margin-bottom: 5px;"> <p>OTHERS [VCR] DATA CODE [VCR] BEEP [VCR] COMMANDER [DISP] DISPLAY [MEM] VIDEO EDIT RETURN [RETN] RETURN TAPE MEMORY [ETC] ETC [MENU] END</p> </div> <div style="text-align: center; font-size: 2em;">➔</div> <div style="border: 1px solid black; padding: 5px;"> <p>VIDEO EDIT 0:08:55:06 MARK 1 IN UNDO ERASE ALL START EDIT SET TOTAL 0:00:00:00 SCENE 0 [RETN] RETURN [MENU] END</p> </div>	<p>6</p> <div style="border: 1px solid black; padding: 5px;"> <p>VIDEO EDIT 0:08:55:06 EDIT SET CONTROL IR ADJ TEST i.LINK "CUT-IN" "CUT-OUT" IR SETUP PAUSEMODE IR TEST RETURN [MENU] END</p> </div>
<p>7</p> <div style="border: 1px solid black; padding: 5px;"> <p>VIDEO EDIT 0:08:55:06 EDIT SET CONTROL i.LINK ADJ TEST "CUT-IN" "CUT-OUT" IR SETUP PAUSEMODE IR TEST RETURN [MENU] END</p> </div>	

When you connect using i.LINK cable (DV connecting cable)
 You cannot dub the titles, display indicators.

Step 3: Adjusting the synchronization of the VCR

You can adjust the synchronization of your camcorder and the VCR. Have a pen and paper ready for notes. Before operation, eject a cassette from your camcorder.

- (1) Set the POWER switch to VCR on your camcorder.
- (2) Insert a blank tape (or a tape you want to record over) into the VCR, then set to recording pause.
When you select i.LINK in CONTROL, you do not need to set to recording pause.
- (3) Select and decide upon ADJ TEST with the control button.
- (4) Select and decide upon EXECUTE with the control button.
IN and OUT are recorded on an image for five times each to calculate the numerical values for adjusting the synchronization.
The EXECUTING indicator flashes on the screen.
When finished, the indicator changes to COMPLETE.
- (5) Rewind the tape in the VCR, then start slow playback.
Take a note of the opening numerical value of each IN and the closing numerical value of each OUT.
- (6) Calculate the average of all the opening numerical values of each IN, and the average of all the closing numerical values of each OUT.
- (7) Select and decide upon "CUT-IN" with the control button.
- (8) Select the average numerical value of IN with the control button.
The calculated start position for recording is set.
- (9) Select and decide upon "CUT-OUT" with the control button.
- (10) Select and decide upon the average numerical value of OUT with the control button.
The calculated stop position for recording is set.
- (11) Select and decide upon ↶ RETURN with the control button.

Dubbing only desired scenes – Digital program editing (on tapes)

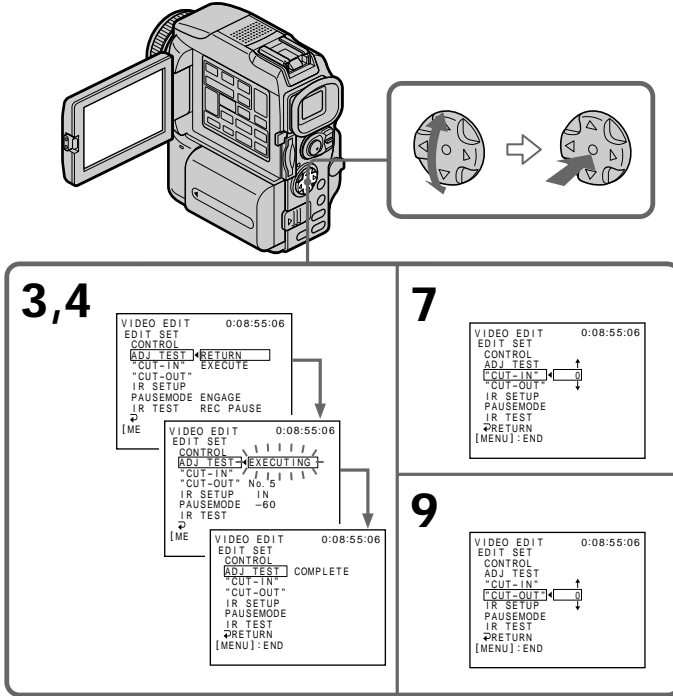

Notes

- When you complete step 3, the image to adjust the synchronization is recorded for about 50 seconds.
- If you start recording from the very beginning of the tape, the first few seconds of the tape may not record properly. Be sure to allow about 10 seconds' lead before starting recording.
- When the recording unit cannot be operated properly by the i.LINK cable (DV connecting cable), leave the connection as it is, and make the A/V connecting cable settings (p. 70). Video and audio are sent by digital signals.

Dubbing only desired scenes – Digital program editing (on tapes)

Operation 1: Making the program

- (1) Insert the tape for playback into your camcorder, and insert a tape for recording into the VCR.
- (2) Press MENU, then select and decide upon VIDEO EDIT in $\overline{\text{ETC}}$ with the control button (p. 96).
- (3) Select and decide upon TAPE with the control button.
- (4) Search for the beginning of the first scene you want to insert using the video operation buttons, then pause playback.
You can fine-adjust one frame at a time with EDITSEARCH.
- (5) Press MARK on the Remote Commander, or ● on the control button.
The IN point of the first program is set, and the top part of the program mark changes to light blue.
- (6) Search for the end of the first scene you want to insert using the video operation buttons, then pause playback.
- (7) Press MARK on the Remote Commander, or ● on the control button.
The OUT point of the first program is set, then the bottom part of the program mark changes to light blue.
- (8) Repeat steps 4 to 7, then set the program.
When the program is set, the program mark changes to light blue.
You can set up to 20 programs.

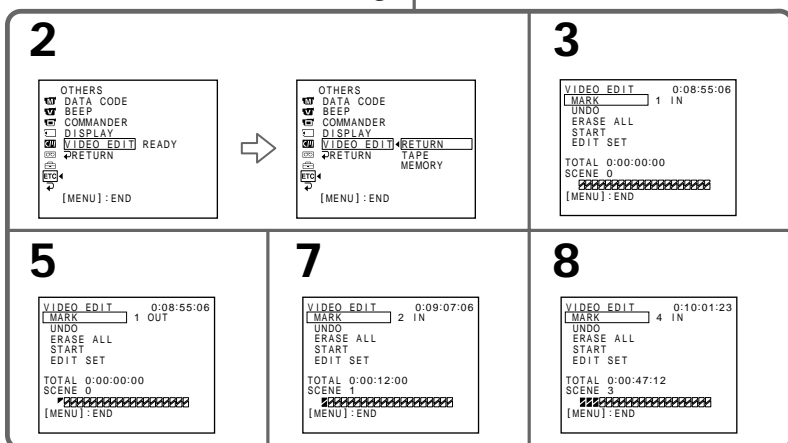
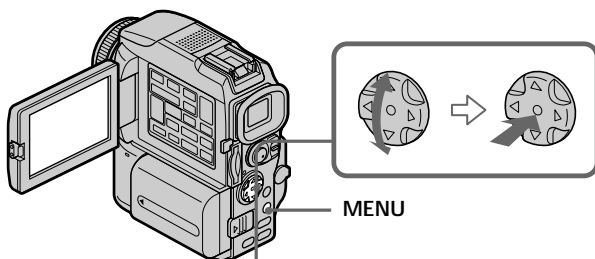

Dubbing only desired scenes – Digital program editing (on tapes)

Erasing the program you have set

Erase OUT first and then IN from of the last program.

- (1) Select and decide upon UNDO with the control button.
- (2) Select and decide upon EXECUTE with the control button.
The last set program mark flashes, then the setting is canceled.

To cancel erasing

Select and decide upon RETURN with the control button in step 2.

Erasing all programs

- (1) Select and decide upon VIDEO EDIT in the menu settings, then select and decide upon TAPE with the control button.
- (2) Select and decide upon ERASE ALL, then select and decide upon EXECUTE with the control button.
All the program marks flash, then the settings are canceled.

To cancel erasing all programs

Select and decide upon RETURN with the control button in step 2.

To cancel a program you have set

Press MENU.

The program is stored in memory until the tape is ejected.

Note

You cannot operate recording during the Digital program editing.

On a blank portion of the tape

You cannot set IN or OUT on a blank portion of the tape.

If there is a blank portion between IN and OUT on the tape

The total time code may not be displayed correctly.

Dubbing only desired scenes – Digital program editing (on tapes)

Operation 2: Performing the program (Dubbing a tape)

Make sure your camcorder and VCR are connected, and that the VCR is set to recording pause. When you use an i.LINK cable (DV connecting cable) the following procedure is not necessary.

When you use a digital video camera recorder, set its power switch to VCR/VTR.

- (1) Select and decide upon VIDEO EDIT, then select and decide upon TAPE with the control button.
- (2) Select and decide upon START, then select and decide upon EXECUTE with the control button.

Search for the beginning of the first program, then start dubbing.

The program mark flashes.

The SEARCH indicator appears during search, and the EDIT indicator appears during edit on the screen.

The PROGRAM indicator changes to light blue after dubbing ends.

When the dubbing ends, your camcorder and the VCR automatically stop.

To stop dubbing during editing

Press ■ using the video operation buttons.

To end the Digital program editing function

Your camcorder stops when the dubbing ends. Then the display returns to VIDEO EDIT in the menu settings.

Press MENU to end the program editing function.

You cannot record on the VCR when:

- The tape has run out.
- The write-protect tab on the cassette is set to lock.
- The IR SETUP code is not correct (when IR is selected).
- The button to cancel recording pause is not correct (when IR is selected).

NOT READY appears on the LCD screen when:

- The program to operate the Digital program editing has not been made.
- i.LINK is selected but an i.LINK cable (DV connecting cable) is not connected.
- The power of the connected VCR is not turned on (when you set i.LINK).

Using with analog video unit and your computer – Signal convert function

You can capture images and sound from an analog video unit connected to your computer which has the i.LINK (DV) jack to your camcorder.

Before operation

Set DISPLAY to LCD in the menu settings. (The default setting is LCD.)

- (1) Set the POWER switch to VCR.
- (2) Press MENU, then select and decide upon A/V → DV OUT in  to ON with the control button (p. 96).
- (3) Start playback on the analog video unit.
- (4) Start capturing procedures on your computer. The operation procedures depend on your computer and the software which you use.

For details on how to capture images, refer to the instruction manual of computer and software.

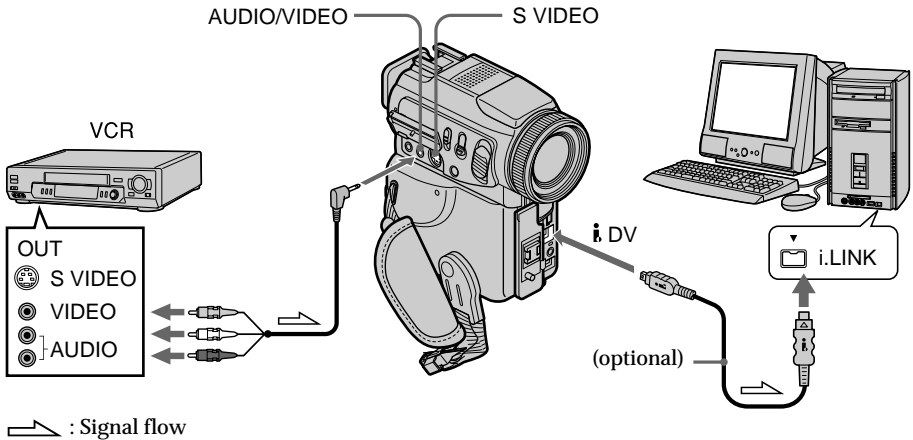

After capturing images and sound

Stop capturing procedures on your computer, and stop the playback on the analog video unit.

Notes

- You need to install software which can exchange video signals.
- Depending on the condition of the analog video signals, the computer may not be able to output the images correctly when you convert analog video signals into digital video signals via your camcorder. Depending on the analog video unit, the image may contain noise or incorrect colors.
- You cannot record or capture the video output via your camcorder when the video tapes include copyright protection signals such as ID-2 system.
- You can capture images and sound with an S video cable (optional) instead of the A/V connecting cable (supplied).

Recording video or TV programs

Using the A/V connecting cable

You can record a tape from another VCR or a TV program from a TV that has video/audio outputs. Use your camcorder as a recorder.

Before operation

Set DISPLAY to LCD in the menu settings. (The default setting is LCD.)

- (1) Insert a blank tape (or a tape you want to record over) into your camcorder. If you are recording a tape from the VCR, insert a recorded tape into the VCR.
- (2) Set the POWER switch to VCR on your camcorder.
- (3) Press ● REC and the button on its right simultaneously on your camcorder, then immediately press || on your camcorder.
- (4) Press ► on the VCR to start playback if you record a tape from a VCR. Select a TV program if you record from a TV. The picture from a TV or VCR appears on the screen.
- (5) Press || on your camcorder at the scene where you want to start recording from.

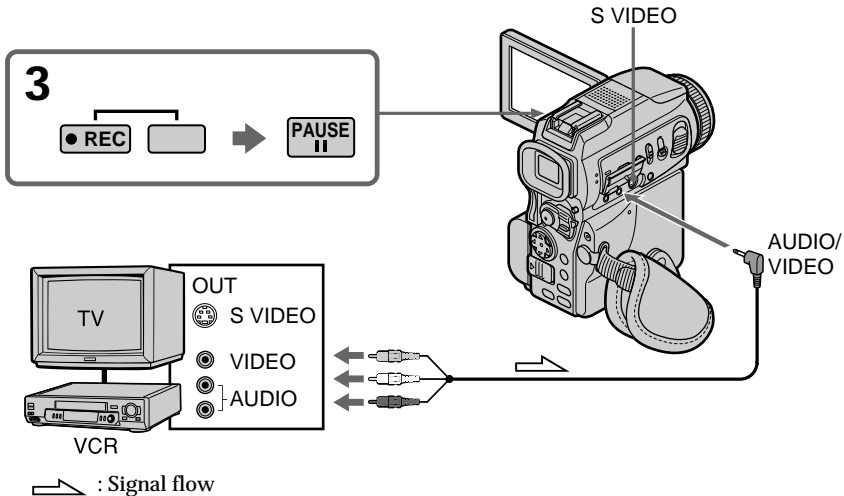

When you have finished dubbing a tape

Press ■ on both your camcorder and the VCR.

Using the Remote Commander

In step 3, press ● REC and MARK simultaneously, then immediately press ||. And in step 5, press || at the scene where you want to start recording from.

If your VCR is a monaural type

Connect the yellow plug of the A/V connecting cable to the video output jack and the white or the red plug to the audio output jack on the VCR or the TV. When the white plug is connected, the left channel audio is output, and when the red plug is connected, the right channel audio is output.

Recording video or TV programs

If your TV or VCR has an S video jack

Pictures can be reproduced more faithfully by using an S video cable (optional).

With this connection, you do not need to connect the yellow (video) plug of the A/V connecting cable.

Connect an S video cable (optional) to the S video jacks of both your camcorder and the TV or VCR.





This connection produces higher quality DV format pictures.

Note on the Remote Commander

Your camcorder works in the commander mode VTR 2. Commander modes 1, 2 and 3 are used to distinguish your camcorder from other Sony VCRs to avoid remote control misoperation. If you use another Sony VCR in the commander mode VTR 2, we recommend changing the commander mode or covering the sensor of the VCR with black paper.

Using the i.LINK cable (DV connecting cable)

Simply connect the i.LINK cable (DV connecting cable) (optional) to  DV jack of your camcorder and to DV OUT of the DV products. With a digital-to-digital connection, video and audio signals are transmitted in digital form for high-quality editing.

- (1) Insert a blank tape (or a tape you want to record over) into your camcorder, and insert the recorded tape into the VCR.
- (2) Set the POWER switch to VCR on your camcorder.
- (3) Press  REC and the button on its right simultaneously on your camcorder, then immediately press  on your camcorder.
- (4) Press  on the VCR to start playback. The picture to be recorded appears on the screen.
- (5) Press  on your camcorder at the scene where you want to start recording from.

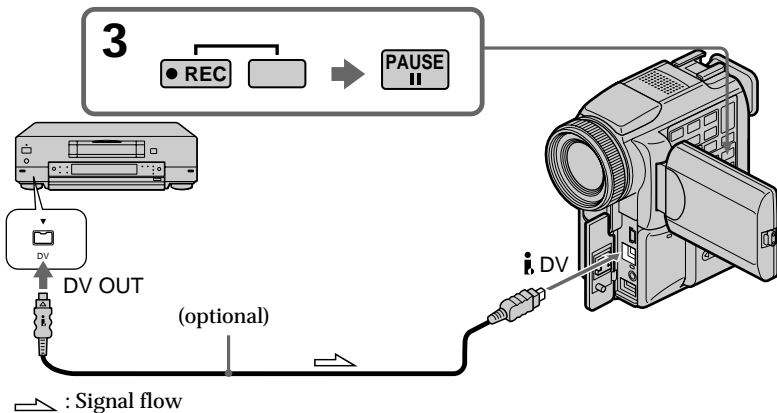

Recording video or TV programs

When you have finished dubbing a tape

Press ■ on both your camcorder and the VCR.

Using the Remote Commander

In step 3, press ● REC and MARK simultaneously, then immediately press ■. And in step 5, press ■ at the scene where you want to start recording from.

You can connect one VCR only using the i.LINK cable (DV connecting cable)

During digital editing

The color of the display may be uneven. However, this does not affect the dubbed picture.

If you record playback pause picture with the i DV jack

The recorded picture becomes rough. And when you play back the picture using your camcorder, the picture may jitter.

Before recording

Make sure that the DV IN indicator appears on the screen. The DV IN indicator may appear on both equipment.

Note on the Remote Commander

Your camcorder works in the commander mode VTR 2. Commander modes 1, 2 and 3 are used to distinguish your camcorder from other Sony VCRs to avoid remote control misoperation. If you use another Sony VCR in the commander mode VTR 2, we recommend changing the commander mode or covering the sensor of the VCR with black paper.

Inserting a scene from a VCR – Insert editing

You can insert a new scene from a VCR onto your originally recorded tape by specifying the insert start and end points. Use the Remote Commander for this operation. Connections are the same as on page 81 or 82.

Insert a cassette containing the desired scene to insert into the VCR.

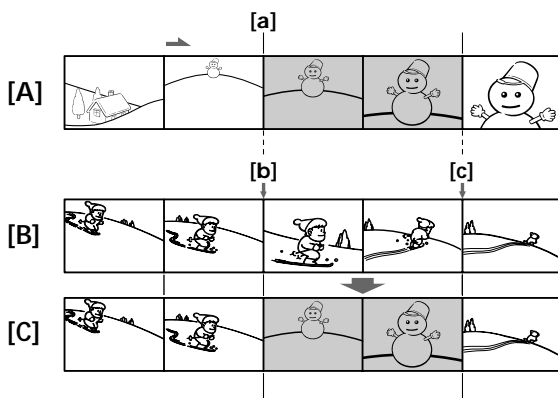

[A]: A tape that contains the scene to be superimposed

[B]: A tape before editing

[C]: A tape after editing

- (1) Set the POWER switch to VCR on your camcorder.
- (2) On the connected VCR, locate just before the insert start point [a], then press **II** to set the VCR to the playback pause mode.
- (3) On your camcorder, locate the insert end point [c]. Then press **II** to set it to the playback pause mode.
- (4) Press ZERO SET MEMORY on the Remote Commander. The ZERO SET MEMORY indicator flashes and the end point of the insert is stored in memory. The tape counter shows "0:00:00."
- (5) On your camcorder, locate the insert start point [b] by pressing **◀◀**, then press **● REC** and the button on its right simultaneously.
- (6) First press **II** on the VCR, and after a few seconds press **II** on your camcorder to start inserting the new scene.

Inserting automatically stops near the zero point on the tape counter. Your camcorder automatically returns to the recording pause mode.

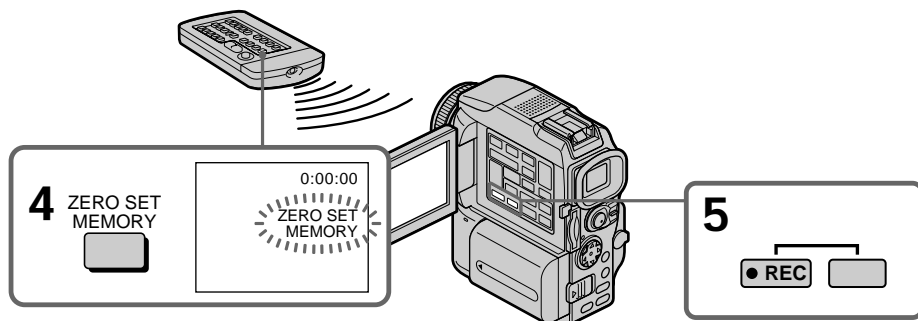

Inserting a scene from a VCR – Insert editing

To change the insert end point

Press ZERO SET MEMORY again after step 5 to erase the ZERO SET MEMORY indicator and begin from step 3.

Using the Remote Commander

In step 5, press ● REC and MARK simultaneously, then immediately press ■■. And in step 6, press ■■ at the scene where you want to start recording from.

Note

The picture and sound recorded on the portion between the insert start and end points will be erased when you insert the new scene.

If you insert scenes on the tape recorded with other camcorder (including other DCR-PC115/PC120BT)

The picture and sound may be distorted. We recommend that you insert scenes on a tape recorded with your camcorder.

When the inserted picture is played back

The picture and sound may be distorted at the end of the inserted portion. This is not a malfunction.

The picture and sound at the start point and the end point may be distorted in the LP mode.

To insert a scene without setting the insert end point

Skip steps 3 and 4. Press ■ when you want to stop inserting.

Note on the Remote Commander

Your camcorder works in the commander mode VTR 2. Commander modes 1, 2 and 3 are used to distinguish your camcorder from other Sony VCRs to avoid remote control misoperation. If you use another Sony VCR in the commander mode VTR 2, we recommend changing the commander mode or covering the sensor of the VCR with black paper.

Audio dubbing

You can record an audio sound to add to the original sound on a tape by connecting audio equipment or a microphone. If you connect the audio equipment, you can add sound to your recorded tape by specifying starting and ending points. The original sound will not be erased.

Use the Remote Commander for this operation.

Select one of the following connections to add an audio sound.

Connecting the microphone with the MIC jack

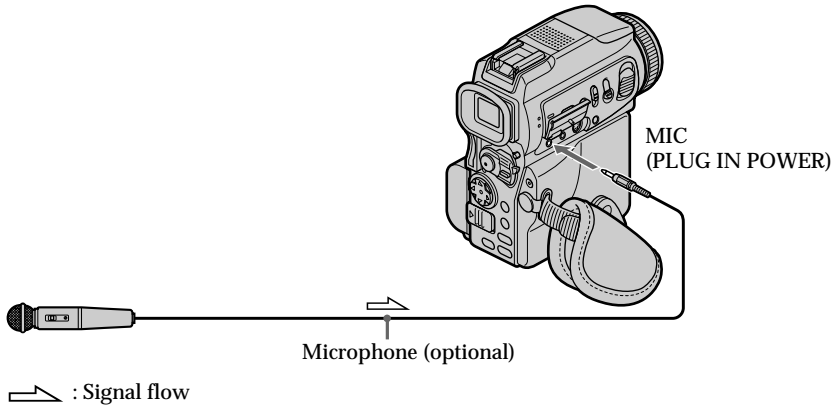

You can check the recorded picture and sound by connecting the AUDIO/VIDEO jack to a TV.

The recorded sound is not output from a speaker. Check the sound by using the TV or headphones.

Connecting the microphone with the intelligent accessory shoe

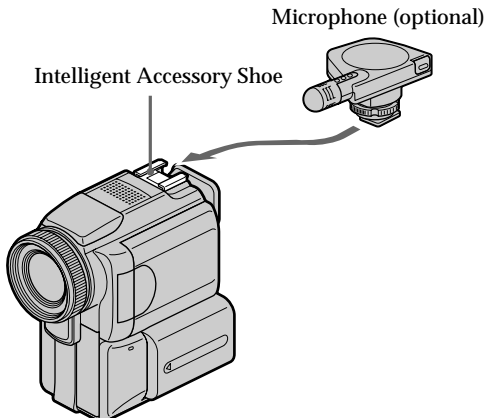

Audio dubbing

Connecting the A/V connecting cable to the AUDIO/VIDEO jack

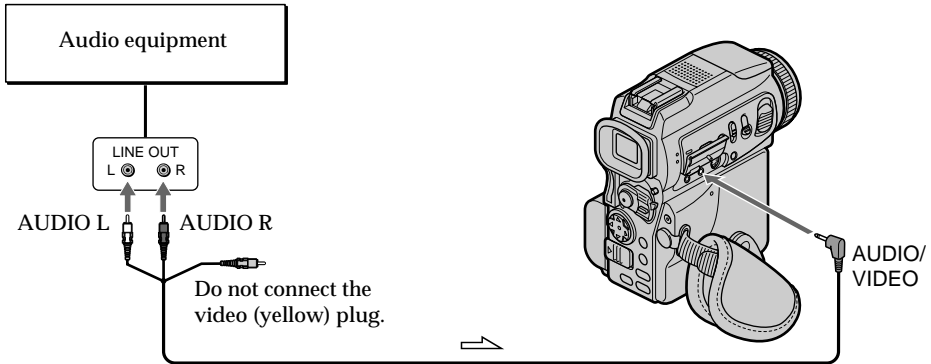

↗ : Signal flow

Dubbing with the built-in microphone

No connection is necessary.

Note

When dubbing with the AUDIO/VIDEO jack or the built-in microphone, pictures are not output through S VIDEO jack or the AUDIO/VIDEO jack. Check the recorded picture on the screen. You can check the recorded sound by using headphones.

If you make all the connections

The audio input to be recorded will take precedence over others in the following order:

- MIC (PLUG IN POWER) jack
- Intelligent accessory shoe
- AUDIO/VIDEO jack
- Built-in microphone

Audio dubbing

Adding an audio sound on a recorded tape

Choose a connection mentioned before, and connect audio equipment or microphone to your camcorder. Then follow the procedure below.

- (1) Insert the recorded tape into your camcorder.
- (2) Set the POWER switch to VCR on your camcorder.
- (3) Locate the recording start point by pressing ►. Then press || at the point where you want to start recording to set your camcorder to the playback pause mode.
- (4) Press AUDIO DUB on the Remote Commander. The green ●|| indicator appears on the screen.
- (5) Press || and start playing back the audio you want to record at the same time. The new sound is recorded in stereo 2 (ST2) during playback. During recording new sound, the red ● appears on the screen.
- (6) Press ■ at the point where you want to stop recording.

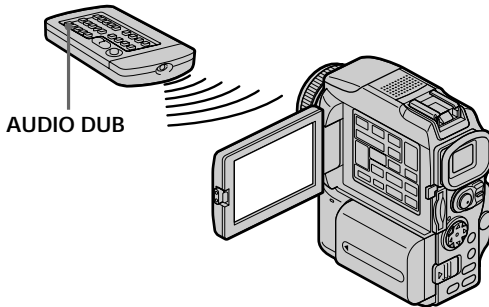

Monitoring the new recorded sound

To play back the sound

Adjust the balance between the original sound (ST1) and the new sound (ST2) by selecting AUDIO MIX in  in the menu settings (p. 96).

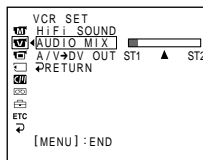

Five minutes after when you disconnect the power source or remove the battery pack, the setting of AUDIO MIX returns to the original sound (ST1) only. The default setting is original sound only.

Notes

- New sound cannot be recorded on a tape already recorded in the 16-bit mode (32 kHz, 44.1 kHz or 48 kHz).
- New sound cannot be recorded on a tape already recorded in the LP mode.
- You cannot add audio with the DV jack.
- You cannot add audio on the blank portion of the tape.

If an i.LINK cable (DV connecting cable) (optional) is connected to your camcorder
You cannot add a sound to a recorded tape.

We recommend that you add new sound on a tape recorded with your camcorder
If you add new sound on a tape recorded with another camcorder (including other DCR-PC115/PC120BT), the sound quality may become worse.

If you set the write-protect tab of the tape to lock
You cannot record on a tape. Slide the write-protect tab to release the write protection.

To add new sound more precisely

Press ZERO SET MEMORY on the Remote Commander at the point where you want to stop recording later in the playback mode.

Carry out from steps 3 to 5. Recording automatically stops at the point where ZERO SET MEMORY was pressed.

Superimposing a title

CM
only

If you use a tape with cassette memory, you can superimpose the title. When you play back the tape, the title is displayed for five seconds from the point where you superimposed it.

You can select one of eight preset titles and two custom titles (p. 93). You can also select the color, size and position of titles.



- (1) Set the POWER switch to CAMERA or VCR. Press MENU, then select and decide upon TITLE in with the control button (p. 96).
- (2) Select and decide upon with the control button.
- (3) Select and decide upon the desired title with the control button. The title flashes.
- (4) Change the color, size, or position, if necessary.
 - ① Select and decide upon the COLOR, SIZE or POSITION with the control button. The item appears.
 - ② Select and decide upon the desired item with the control button.
 - ③ Repeat steps ① and ② until the title is laid out as desired.
- (5) Press ● on the control button again to complete the setting.

In the recording, playback or playback pause mode:

The TITLE SAVE indicator appears on the screen for five seconds and the title is set.

In the standby mode:

The TITLE indicator appears. And when you press START/STOP to start recording, TITLE SAVE appears on the screen for five seconds and the title is set.

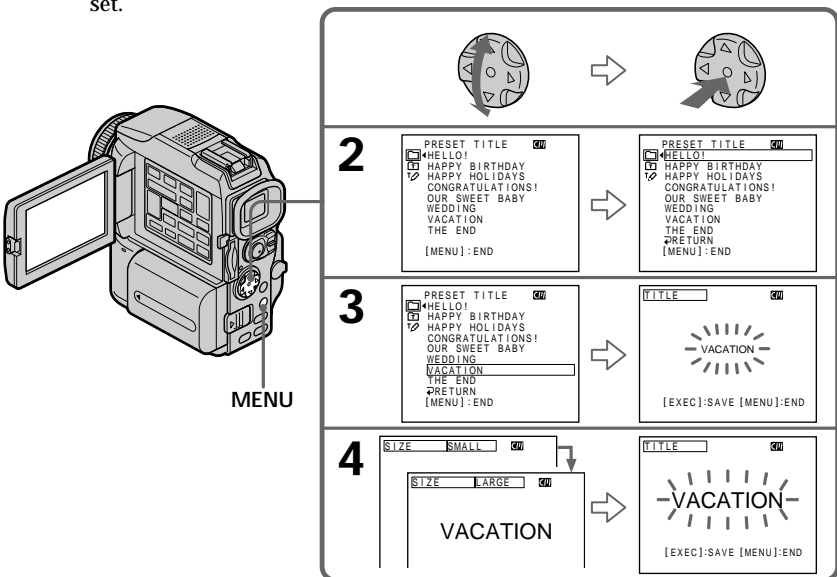

Superimposing a title

If you set the write-protect tab of the tape to lock

You cannot superimpose or erase the title. Slide the write-protect tab to release the write protection.

To use the custom title

If you want to use the custom title, select  in step 2.

If the tape has a blank portion

You cannot superimpose a title on the portion.

If the tape has a blank portion in the middle of the recorded parts

The title may not be displayed correctly.

The titles superimposed with your camcorder

- They are displayed by only the DV ^{Mini} DV format video equipment with index titler function.
- The point you superimposed the title may be detected as an index signal when searching a recording with other video equipment.

If the tape has too many index signals

You may not be able to superimpose a title because the memory is full. In this case, delete data you do not need.

Not to display titles

Set TITLE DSPL to OFF in the menu settings (p. 96).

Title setting

- The title color changes as follows:
WHITE ↔ YELLOW ↔ VIOLET ↔ RED ↔ CYAN ↔ GREEN ↔ BLUE
- The title size changes as follows:
SMALL ↔ LARGE
You cannot input 13 characters or more in LARGE size. If you input more than 12 characters, the title size returns to SMALL even you select LARGE.
- If you select SMALL, you have nine choices for the title position.
If you select LARGE, you have eight choices for the title position.

One cassette can have up to about 20 titles, if one title consists of five characters

However, if the cassette memory is full with date, photo and cassette label data, one cassette can have only up to about 11 titles with five characters each.

Cassette memory capacity is as follows:

- 6 date data
- 12 photo data
- 1 cassette label

If the " FULL" mark appears

The cassette memory is full. Erase the title you do not need.

Superimposing a title

Erasing a title

- (1) Set the POWER switch to CAMERA or VCR.
- (2) Press MENU, then select and decide upon TITLEERASE in  with the control button (p. 96).
- (3) Select and decide upon the title you want to erase with the control button. ERASE OK ? indicator appears.
- (4) Make sure the title is the one you want to erase, and select and decide upon OK with the control button. OK changes to EXECUTE.
- (5) Select and decide upon EXECUTE with the control button. ERASING flashes on the screen. When the title is erased, COMPLETE is displayed.

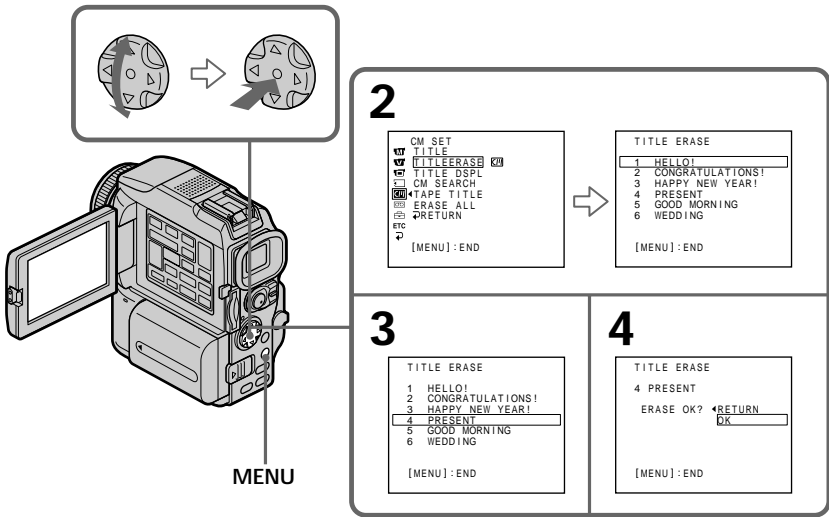



To cancel erasing a title

Select and decide upon RETURN in step 5.

Making your own titles

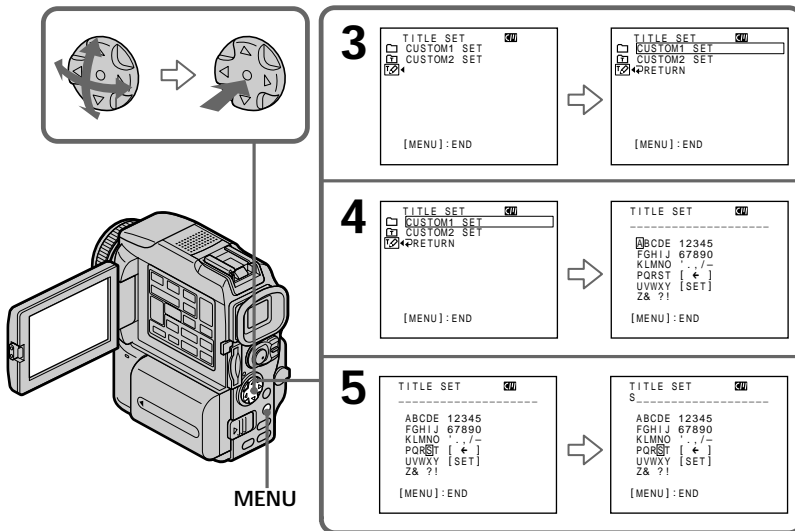

You can make up to two titles and store them in the memory of your camcorder. Each title can have up to 20 characters.

- (1) Set the POWER switch to CAMERA or VCR.
- (2) Press MENU, then select and decide upon TITLE in  with the control button (p. 96).
- (3) Select and decide upon  with the control button.
- (4) Select and decide upon CUSTOM1 SET or CUSTOM2 SET with the control button.
- (5) Select and decide upon the desired character with the control button.
- (6) Repeat steps 5 to complete making your own title.
- (7) To finish making your own titles, select and decide upon [SET] with the control button.



To change a title you have stored

In step 4, select the original title you want to change, and then press  on the control button.

Select  to select the title to delete, then press  to delete the last character of your title. Enter the new title as desired.

If you take five minutes or longer to enter characters in the standby mode while a cassette is in your camcorder

The power automatically goes off. The characters you have entered remain stored in memory. Set the POWER switch to OFF (CHG) once and then to CAMERA again, then proceed from step 1.

We recommend setting the POWER switch to VCR or removing the cassette so that your camcorder does not automatically turn off while you are entering title characters.

To erase the title

Select . The last character is erased.

To enter a space

Select [Z& ?!], then select the blank part.

Labeling a cassette

CM only

If you use a tape with cassette memory, you can label a cassette. The label can consist of up to 10 characters and is stored in cassette memory. When you insert the labelled cassette and turn the power on, the label is displayed for about five seconds.

- (1) Insert the cassette you want to label.
- (2) Set the POWER switch to CAMERA or VCR.
- (3) Press MENU, then select and decide upon TAPE TITLE in  with the control button (p. 96).
Tape title display appears.
- (4) Select and decide upon the desired character with the control button.
- (5) Repeat steps 4 until you complete the label.
- (6) Select and decide upon [SET] with the control button.
The label is stored in memory.

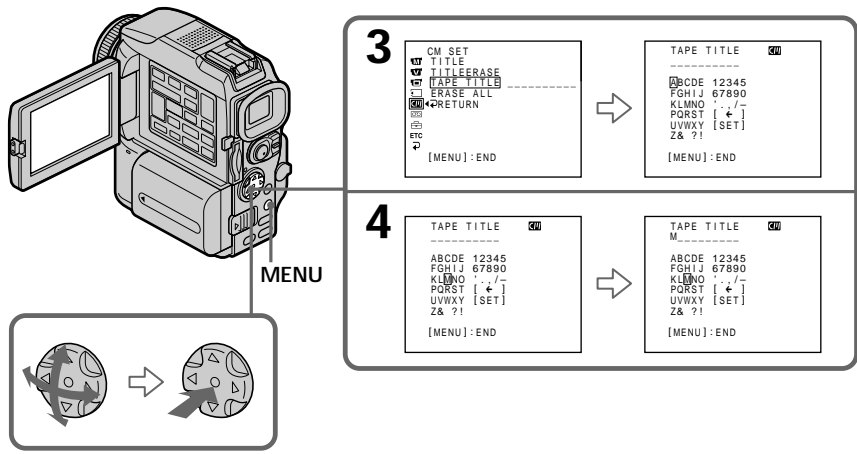

Labeling a cassette

To erase the label you have made

Select and decide upon [←] with the control button in step 4. The last character is erased.

To change the label you have made

Insert the cassette to change the label, and operate in the same way to make a new label.

If you set the write-protect tab of the tape to lock

You cannot label a cassette. Slide the write-protect tab to release the write protection.

If the tape has too many index signals

You may not be able to label a cassette because the memory is full. In this case, delete data you do not need.

If you have superimposed titles in the cassette

When the label is displayed, up to four titles also appear.

When the "-----" indicator has fewer than 10 spaces

The cassette memory is full.

The "-----" indicates the number of characters you can select for the label.

To erase the character

Press [←]. The last character is erased.

To enter a space

Select [Z& ?!], then select the blank part.

Erasing all the data in cassette memory

You can erase all the data in cassette memory at once.

- (1) Set the POWER switch to CAMERA or VCR.
- (2) Press MENU, then select and decide upon ERASE ALL in [C] with the control button (p. 96).
- (3) Select and decide upon OK with the control button. OK changes to EXECUTE.
- (4) Select and decide upon EXECUTE with the control button. ERASING flashes on the screen. When all the data is erased, COMPLETE is displayed.

To cancel deleting

Select and decide upon RETURN with the control button in step 4.

Changing the menu settings

To change the mode settings in the menu settings, select the menu items with the control button. The default settings can be partially changed. First, select the icon, then the menu item and then the mode.

- (1) Set the POWER switch to CAMERA, VCR or MEMORY, press MENU.
- (2) Press ▲/▼ on the control button to select the desired icon, then press ● or ►.
- (3) Press ▲/▼ on the control button to select the desired item, then press ● or ►.
- (4) Press ▲/▼ on the control button to select the desired mode, then press ●.
- (5) If you want to change other items, select ↶ RETURN and press ● or ◀, then repeat steps 2 to 4.

For details, see “Selecting the mode setting of each item” (p. 97).

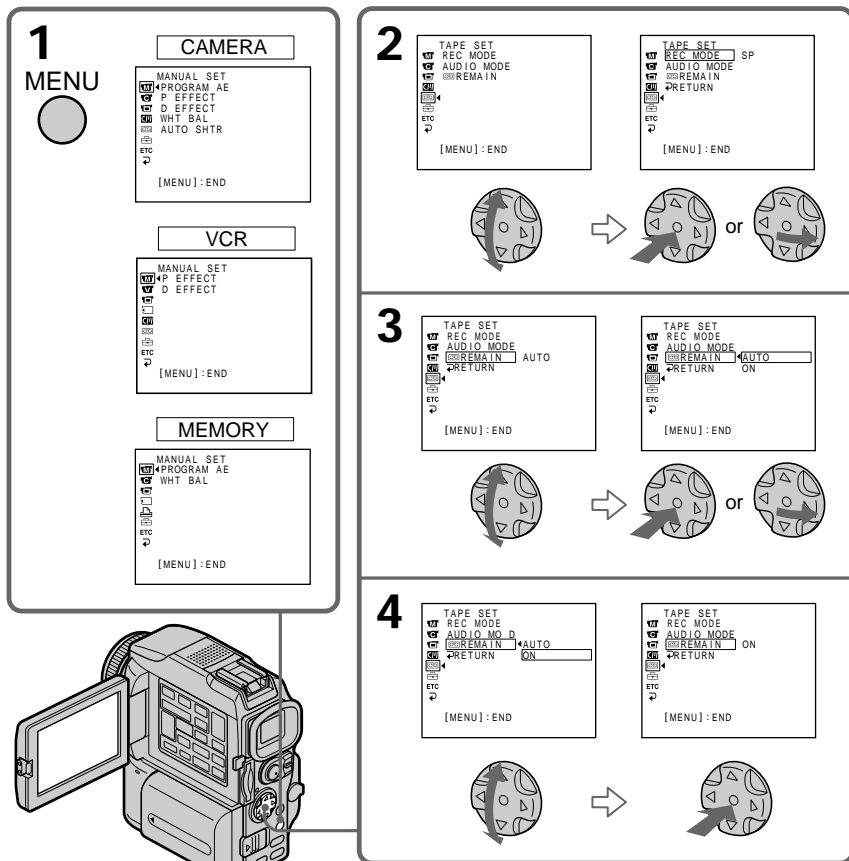

To make the menu display disappear
Press MENU.

This manual refers to selecting and deciding upon items by the above procedure as “Select and decide upon [(item name)].”



Changing the menu settings

Menu items are displayed as the following icons:

-  MANUAL SET
-  CAMERA SET
-  VCR SET
-  LCD/VF SET
-  MEMORY SET
-  PRINT SET
-  CM SET
-  TAPE SET
-  SETUP MENU
-  OTHERS

Selecting the mode setting of each item ● is the default setting.

Menu items differ depending on the position of the POWER switch. The screen shows only the items you can operate at the moment.

Icon/Item	Mode	Meaning	POWER switch
 PROGRAM AE	---	To suit your specific shooting requirement (p. 49).	CAMERA MEMORY
P EFFECT	---	To add special effects like those in films or on the TV to images (p. 45, 58).	VCR CAMERA
D EFFECT	---	To add special effects using the various digital functions (p. 46, 59).	VCR CAMERA
WHT BAL	---	To adjust the white balance (p. 40).	CAMERA MEMORY
AUTO SHTR	● ON	To automatically activate the electronic shutter when shooting in bright conditions.	CAMERA
	OFF	Not to automatically activate the electronic shutter even when shooting in bright conditions.	
 D ZOOM	● OFF	To deactivate the digital zoom. Up to 10× zoom is carried out.	CAMERA
	20×	To activate the digital zoom. More than 10× to 20× zoom is performed digitally (p. 24).	
	120×	To activate the digital zoom. More than 10× to 120× zoom is performed digitally (p. 24).	
16:9WIDE	● OFF	—	CAMERA
	ON	To record a 16:9 wide picture (p. 41).	
STEADYSHOT	● ON	To compensate for camera-shake.	CAMERA
	OFF	To cancel the SteadyShot function. Natural pictures are produced when shooting a stationary object with a tripod.	
N.S. LIGHT	● ON	To use the NightShot Light function (p. 28).	CAMERA MEMORY
	OFF	To cancel the NightShot Light function.	



Notes on the SteadyShot function

- The SteadyShot function will not correct excessive camera-shake.
- Attachment of a conversion lens (optional) may influence the SteadyShot function.

If you cancel the SteadyShot function

The SteadyShot off indicator  appears. Your camcorder prevents excessive compensation for camera-shake.



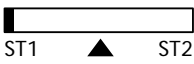

Changing the menu settings

Icon/item	Mode	Meaning	POWER switch
 FRAME REC	● OFF	To deactivate Cut recording function.	CAMERA
	ON	To activate Cut recording function (p. 57).	
INT. REC	ON	To activate Interval recording function (p. 55).	CAMERA
	● OFF	To deactivate Interval recording function.	
	SET	To set INTERVAL and REC TIME for Interval recording function.	
FLASH LVL	HIGH	Makes the flash level higher than normal.	CAMERA MEMORY
	● NORMAL	Normal setting.	
	LOW	Makes the flash level lower than normal.	
HOLOGRAM F	● AUTO	The HOLOGRAM AF emits when focusing on subjects is difficult in dark places (p. 116).	MEMORY
	OFF	The HOLOGRAM AF does not emit.	
 HiFi SOUND	● STEREO	To play back a stereo tape or dual sound track tape with main and sub sound (p. 166).	VCR
	1	To play back a stereo tape with the left sound or a dual sound tape with main sound.	
	2	To play back a stereo tape with the right sound or a dual sound track tape with sub sound.	
	AUDIO MIX	---	
			
A/V→DV OUT	● OFF	To output digital images and sound in analog format using your camcorder.	VCR
	ON	To output analog images and sound in digital format using your camcorder (p. 80).	

Note on FLASH LVL

You cannot adjust FLASH LVL if the external flash (optional) is not compatible with the flash level.

Changing the menu settings

Icon/item	Mode	Meaning	POWER switch
 LCD BRIGHT	---	To adjust the brightness on the LCD screen with ◀/▶ on the control button. 	VCR CAMERA MEMORY
LCD B. L.	● BRT NORMAL BRIGHT	To set the brightness on the LCD screen normal. To brighten the LCD screen.	VCR CAMERA MEMORY
LCD COLOR	---	To adjust the color on the LCD screen, press ◀/▶ on the control button. 	VCR CAMERA MEMORY
VF B.L.	● BRT NORMAL BRIGHT	To set the brightness on the viewfinder screen to normal. To brighten the viewfinder screen.	VCR CAMERA MEMORY
 STILL SET			
PIC MODE	● SINGLE NORMAL HIGH SPEED MULTI SCRN	Not to record continuously. To record from three to nine images continuously (p. 113). To record up to 16 images continuously fast. To record nine images continuously, display the images on a single page divided into nine boxes.	MEMORY
QUALITY	● SUPER FINE FINE STANDARD	To record still images in the finest image quality mode (p. 107). To record still images in the fine image quality mode. To record still images in the standard image quality mode.	VCR MEMORY
IMAGESIZE	● 1360 × 1020 640 × 480	To record still images in 1360 × 1020 size (p. 109). To record still images in 640 × 480 size.	MEMORY



Notes on LCD B.L. and VF B.L.

- When you select BRIGHT, battery life is reduced by about 10 percent during recording.
- When you use power sources other than the battery pack, BRIGHT is automatically selected.

Even if you adjust LCD BRIGHT, LCD B.L., LCD COLOR and/or VF B.L.
The recorded picture will not be affected.

(Continued on the following page)

Changing the menu settings

Icon/item	Mode	Meaning	POWER switch
 MOVIE SET			
IMAGESIZE	● 320 × 240	To record moving pictures in 320 × 240 size (p. 109).	VCR MEMORY
	160 × 112	To record moving pictures in 160 × 112 size.	
 REMAIN	● AUTO	To display the remaining capacity of the “Memory Stick” in the following cases: <ul style="list-style-type: none"> • For five seconds after inserting a “Memory Stick” into your camcorder • When the capacity of the “Memory Stick” is less than one minute in MEMORY mode • For five seconds after completing a moving picture recording 	VCR MEMORY
	ON	To always display the remaining capacity of the “Memory Stick.”	
PRINT MARK	ON	To write a print mark on the recorded still images you want to print out later (p. 153).	VCR MEMORY
	● OFF	To cancel print marks on still images.	
PROTECT	ON	To protect selected images against accidental erasure (p. 150).	VCR MEMORY
	● OFF	Not to protect images.	
SLIDE SHOW	---	To play back images in a continuous loop (p. 149).	MEMORY
DELETE ALL	---	To delete all the unprotected images (p. 152).	MEMORY
FORMAT	● RETURN	To cancel formatting.	MEMORY
	OK	To format an inserted “Memory Stick.” <ol style="list-style-type: none"> 1. Select FORMAT. 2. Select and decide upon OK with the control button. 3. After EXECUTE appears, press ● on the control button. FORMATTING flashes during formatting. COMPLETE appears when formatting is finished. 	
PHOTO SAVE	---	To duplicate still images on tape onto “Memory Stick” (p. 135).	VCR

Notes on formatting



- Supplied “Memory Stick”s have been formatted at factory. Formatting with this camcorder is not required.
- Do not turn the POWER switch or press any button while the display shows FORMATTING.
- You cannot format the “Memory Stick” if the write-protect tab on the “Memory Stick” is set to LOCK.
- Format the “Memory Stick” when  FORMAT ERROR is displayed.

Formatting erases all information on the “Memory Stick”

Check the contents of the “Memory Stick” before formatting.

- Formatting erases sample images on the “Memory Stick.”
- Formatting erases the protected image data on the “Memory Stick.”

Changing the menu settings



Icon/item	Mode	Meaning	POWER switch
 9PIC PRINT	● RETURN	To cancel prints of split screen.	MEMORY
	SAME	To make prints of same split screen (p. 154).	
	MULTI	To make prints of different split screen.	
	MARKED	To make prints of images with print marks in recording order.	
DATE/TIME	● OFF	To make prints without the recording date and time.	MEMORY
	DATE	To make prints with the recording date (p. 154).	
	DAY&TIME	To make prints with the recording date and time.	
 TITLE	---	To superimpose a title or make your own title (p. 90, 93).	VCR CAMERA
TITLEERASE	---	To erase the title you have superimposed (p. 92).	VCR CAMERA
TITLE DSPL	● ON	To display the title you have superimposed.	VCR
	OFF	Not to display the title.	
CM SEARCH	● ON	To search using cassette memory (p. 62, 63, 65).	VCR
	OFF	To search without using cassette memory.	
TAPE TITLE	---	To label a cassette (p. 94).	VCR CAMERA
ERASE ALL	---	To erase all the data in cassette memory (p. 95).	VCR CAMERA

Note on PRINT SET

9PIC PRINT and DATE/TIME are displayed only when an external printer (optional) is connected to the intelligent accessory shoe.

(Continued on the following page)

Changing the menu settings

Icon/item	Mode	Meaning	POWER switch
 REC MODE	● SP	To record in the SP (Standard Play) mode.	VCR
	LP	To increase the recording time to 1.5 times the SP mode.	CAMERA
AUDIO MODE	● 12BIT	To record in the 12-bit mode (two stereo sounds).	VCR
	16BIT	To record in the 16-bit mode (one stereo sound with high quality).	CAMERA
 REMAIN	● AUTO	To display the remaining tape bar: • for about eight seconds after a cassette is inserted and your camcorder calculates the remaining amount of tape. • for about eight seconds after ► or DISPLAY is pressed.	VCR CAMERA
	ON	To always display the remaining tape indicator.	
 CLOCK SET	---	To set the date or time (p. 16).	CAMERA MEMORY
LTR SIZE	● NORMAL	To display selected menu items in normal size.	VCR
	2×	To display selected menu items at twice the normal size.	CAMERA MEMORY
DEMO MODE	● ON	To make the demonstration appear.	CAMERA
	OFF	To cancel the demonstration mode.	

Notes on the LP mode

- When you record a tape in the LP mode on your camcorder, we recommend playing the tape on your camcorder. When you play back the tape on other camcorders or VCRs, noise may occur in pictures or sound.
- When you record in the LP mode, we recommend using a Sony Excellence/Master cassette so that you can get the most out of your camcorder.
- You cannot make audio dubbing on a tape recorded in the LP mode. Use the SP mode for the tape to be audio dubbed.
- When you record in the SP and LP modes on one tape or you record some scenes in the LP mode, the playback picture may be distorted or the time code may not be written properly between scenes.

Notes on AUDIO MODE

- You cannot dub audio sound on a tape recorded in the 16-bit mode.
- When playing back a tape recorded in the 16-bit mode, you cannot adjust the balance in AUDIO MIX.

Notes on DEMO MODE

- You cannot select DEMO MODE when a cassette is inserted in your camcorder.
- When NIGHTSHOT is set to ON, the "NIGHTSHOT" indicator appears on the screen and you cannot select DEMO MODE in the menu settings.
- DEMO MODE is set to STBY (Standby) as the default setting and the demonstration starts about 10 minutes after you have set the POWER switch to CAMERA without a cassette inserted.

To cancel the demonstration, insert a cassette, set the POWER switch to other than CAMERA, or set DEMO MODE to OFF. To set to STBY (Standby) again, leave the DEMO MODE at ON in the menu settings, turn the POWER switch OFF (CHG), and return the POWER switch to CAMERA.

Changing the menu settings

Icon/item	Mode	Meaning	POWER switch
[Etc] DATA CODE	● DATE/CAM	To display date, time and various settings during playback (p. 32).	VCR MEMORY
	DATE	To display date and time during playback.	
AREA SET	---	Temporarily change the area where you are using your camcorder.	CAMERA MEMORY
DST SET*	● OFF	Not during daylight saving time.	CAMERA MEMORY
	ON	During daylight saving time.	
BEEP	● MELODY	To output the melody when you start/stop recording or when an unusual condition occurs on your camcorder.	VCR CAMERA MEMORY
	NORMAL	To output the beep instead of the melody.	
	OFF	To cancel all sound including shutter sound.	
COMMANDER	● ON	To activate the Remote Commander supplied with your camcorder.	VCR CAMERA MEMORY
	OFF	To deactivate the Remote Commander to avoid remote control misoperation caused by other VCR's remote control.	
DISPLAY	● LCD	To show the display on the LCD screen and in the viewfinder.	VCR CAMERA MEMORY
	V-OUT/LCD	To show the display on the TV screen, LCD screen and in the viewfinder.	
REC LAMP	● ON	To light up the camera recording lamp at the front of your camcorder.	CAMERA MEMORY
	OFF	To turn the camera recording lamp off so that the person is not aware of the recording.	
VIDEO EDIT	● RETURN	To cancel video editing.	VCR
	TAPE	To make program and perform video editing (p. 69).	
	MEMORY	To make program and perform MPEG editing (p. 132).	

* Instead of DST, SUMMERTIME is displayed on the screen for some models.

Note

If you press DISPLAY with DISPLAY set to V-OUT/LCD in the menu settings, the picture from a TV or VCR will not appear on the LCD screen even when your camcorder is connected to outputs on the TV or VCR.

When recording a close subject

When REC LAMP is set to ON, the red camera recording lamp on the front of the camcorder may reflect on the subject if it is close. In this case, we recommend you set REC LAMP to OFF.

In more than five minutes after removing the power source

The PROGRAM AE, WHT BAL, FLASH LVL, HiFi SOUND, AUDIO MIX and COMMANDER items are returned to their default settings.
The other menu items are held in memory even when the battery is removed.

Using a “Memory Stick” – introduction

You can record and play back images on a “Memory Stick” supplied with your camcorder. You can easily play back, record or delete images. You can exchange image data with other equipment such as your computer etc., using the USB cable for “Memory Stick” supplied with your camcorder.

On file format

Still image (JPEG)

Your camcorder compresses image data in JPEG format (extension .jpg).

Moving picture (MPEG)

Your camcorder compresses picture data in MPEG format (extension .mpg).

Typical image data file name

Still image

100-0001: This file name appears on the screen of your camcorder.

Dsc00001.jpg: This file name appears on the display of your computer.

Moving picture

MOV00001: This file name appears on the screen of your camcorder.

Mov00001.mpg: This file name appears on the display of your computer.

Using a “Memory Stick”

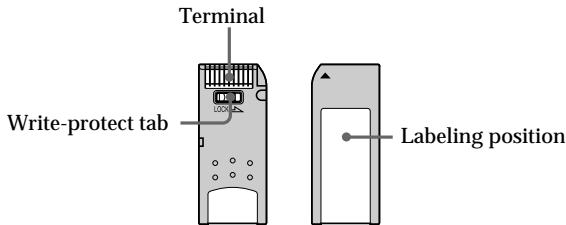

- You cannot record or erase images when the write-protect tab on the “Memory Stick” is set to LOCK.
- The position and shape of the write-protect tab may be different depending on the model.
- We recommend backing up important data on the hard disk of your computer.
- Image data may be damaged in the following cases:
 - If you remove the “Memory Stick” or turn the power off during reading or writing.
 - If you use “Memory Stick”s near static electricity or magnetic fields.
- Prevent metallic objects or your finger from coming into contact with the metal parts of the connecting section.
- Stick its label on the labeling position.
- Do not bend, drop or apply strong shock to “Memory Stick”s.
- Do not disassemble or modify “Memory Stick”s.
- Do not let “Memory Stick”s get wet.
- Do not use or keep “Memory Stick”s in locations that are:
 - Extremely hot such as in a car parked in the sun or under the scorching sun.
 - Under direct sunlight.
 - Very humid or subject to corrosive gases.
- When you carry or store a “Memory Stick,” put it in its case.

“Memory Stick”s formatted by a computer

“Memory Stick”s formatted by Windows OS or Macintosh computers do not have a guaranteed compatibility with this camcorder.

Notes on image data compatibility

- Image data files recorded on “Memory Stick”s by your camcorder conform with the Design Rules for Camera File Systems universal standard established by the JEITA (Japan Electronics and Information Technology Industries Association). You cannot play back on your camcorder still images recorded on other equipment (DCR-TRV890E/TRV900/TRV900E or DSC-D700/D770) that does not conform with this universal standard. (These models are not sold in some areas.)
- If you cannot use the “Memory Stick” that is used with other equipment, format it with this camcorder (p. 100). However, formatting erases all information on the “Memory Stick.”

-
- “Memory Stick” and  are trademarks of Sony Corporation.
 - Windows and Windows Media are either registered trademarks or trademarks of Microsoft Corporation in the United States and/or other countries.
 - Macintosh and Mac OS, QuickTime are trademarks of Apple Computer, Inc.
 - RealPlayer is either a registered trademark or trademark of RealNetworks, Inc. in the United States and/or other countries.
 - All other product names mentioned herein may be the trademarks or registered trademarks of their respective companies.
- Furthermore, “™” and “®” are not mentioned in each case in this manual.

Using a “Memory Stick” – introduction

Inserting a “Memory Stick”

Insert a “Memory Stick” in the “Memory Stick” slot as far as it can go with the ◀ mark facing as illustrated.

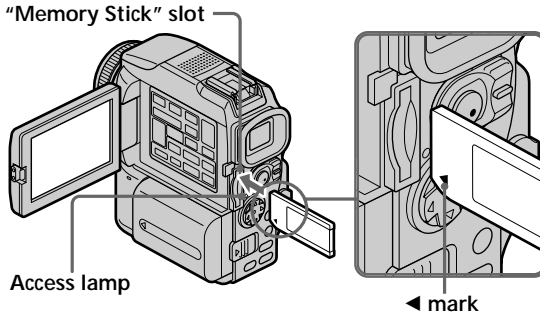

Ejecting a “Memory Stick”

Press the “Memory Stick” once lightly.

While the access lamp is lit or flashing

Do not shake or strike your camcorder because your camcorder is reading the data from the “Memory Stick” or recording the data on the “Memory Stick.” Do not turn the power off, eject a “Memory Stick” or remove the battery pack. Otherwise, the image data breakdown may occur.

If “ MEMORYSTICK ERROR” is displayed

Reinsert “Memory Stick” a few times. The “Memory Stick” may be damaged if the indicator is still displayed. If this occurs, use another “Memory Stick.”

Using a "Memory Stick" – introduction

Selecting still image quality mode

You can select image quality mode in still image recording. The default setting is SUPER FINE.

- (1) Set the POWER switch to MEMORY or VCR. Make sure that the LOCK switch is set to the right (unlock) position.
- (2) Press MENU, then select and decide upon STILL SET in  with the control button (p. 96).
- (3) Select and decide upon QUALITY with the control button.
- (4) Select and decide upon the desired image quality with the control button.

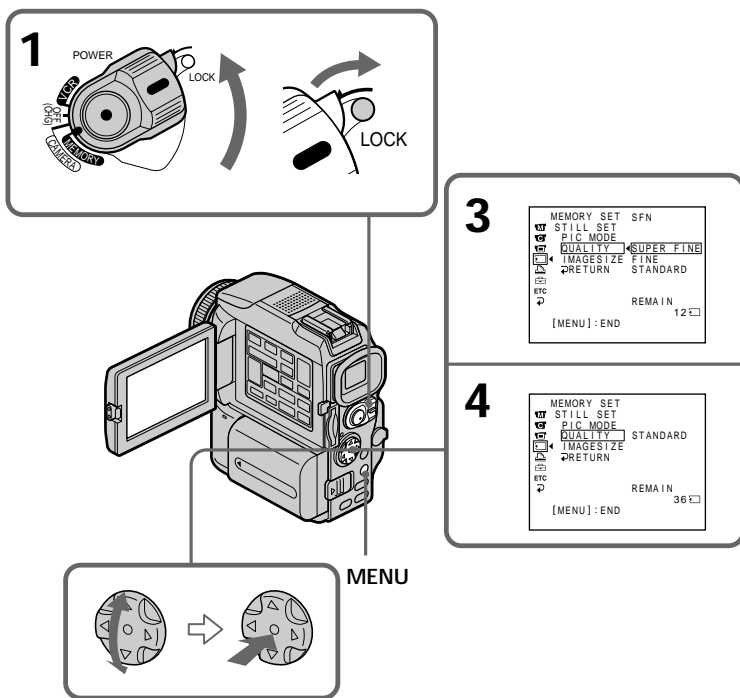

Using a “Memory Stick” – introduction

Image quality settings

Setting	Meaning
SUPER FINE (SFN)	This is the highest image quality in your camcorder. The number of still images you can record is less than in FINE mode. The image is compressed to about 1/3.
FINE (FINE)	Use this mode when you want to record high quality images. The image is compressed to about 1/6.
STANDARD (STD)	This is the standard image quality. The image is compressed to about 1/10.

Note

In some cases, changing the image quality mode may not affect the image quality, depending on the types of images you are shooting.

Differences in image quality mode

Recorded images are compressed in JPEG format before being stored in memory. The memory capacity allotted to each image varies depending on the selected image quality mode and image size. Details are shown in the table below. (You can select 1360 × 1020 or 640 × 480 image size in the menu settings.)

1360 × 1020 image size

Image quality mode	Memory capacity
SUPER FINE	About 900 KB
FINE	About 450 KB
STANDARD	About 300 KB

640 × 480 image size

Image quality mode	Memory capacity
SUPER FINE	About 190 KB
FINE	About 100 KB
STANDARD	About 60 KB

Image quality mode indicator

The image quality mode indicator is not displayed during playback.

When you select image quality

The number of images you can shoot in the currently selected image quality appears on the screen.

Using a "Memory Stick" – introduction

Selecting the image size

You can select either of two image sizes

Still images: 1360 × 1020 or 640 × 480. (When the POWER switch is set to VCR, the image size is automatically set to 640 × 480.)





The default setting is 1360 × 1020.

Moving pictures: 320 × 240 or 160 × 112

The default setting is 320 × 240.

- (1) Set the POWER switch to MEMORY. Make sure that the LOCK switch is set to the right (unlock) position.
- (2) Press MENU, then select and decide upon STILL SET (still image) or MOVIE SET (moving picture) in  with the control button (p. 96).
- (3) Select and decide upon IMAGESIZE with the control button.
- (4) Select and decide upon the desired image size with the control button.

The indicator changes as follows:

Still images:  ↔ 
Moving pictures:  ↔ 

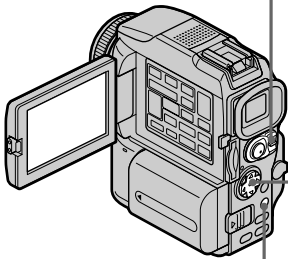
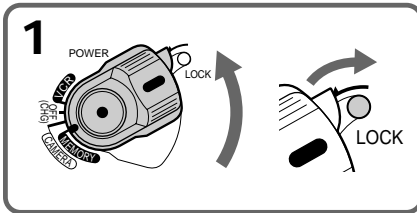



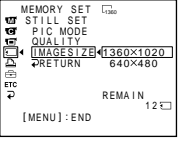
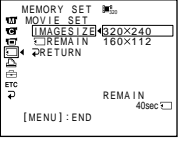
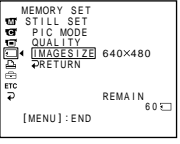
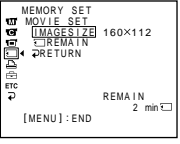



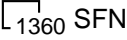

MENU

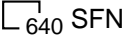
3 STILL SET 	MOVIE SET 
4 STILL SET 	MOVIE SET 

Using a “Memory Stick” – introduction

Image size settings

Setting	Meaning	Indicator	
		Recording	Playback
1360 × 1020	Records 1360 × 1020 still images.		
640 × 480	Records 640 × 480 still images.		
320 × 240	Records 320 × 240 moving pictures.		
160 × 112	Records 160 × 112 moving pictures.		

Maximum recording time of moving pictures

Image size	Maximum recording time
320 × 240	15 seconds
160 × 112	60 seconds

Using a “Memory Stick” – introduction

Approximate number of still images you can record on a “Memory Stick”

The number of images you can record varies depending on which image quality and image size you select and the complexity of the subject.

Type	Image quality	640 × 480	1360 × 1020
4MB (optional)	SUPER FINE (SFN)	19 images	4 images
	FINE (FINE)	39 images	8 images
	STANDARD (STD)	58 images	12 images
8MB (supplied)	SUPER FINE (SFN)	40 images	8 images
	FINE (FINE)	80 images	17 images
	STANDARD (STD)	120 images	25 images
16MB (optional)	SUPER FINE (SFN)	80 images	17 images
	FINE (FINE)	160 images	34 images
	STANDARD (STD)	240 images	50 images
32MB (optional)	SUPER FINE (SFN)	160 images	35 images
	FINE (FINE)	325 images	69 images
	STANDARD (STD)	485 images	100 images
64MB (optional)	SUPER FINE (SFN)	325 images	71 images
	FINE (FINE)	650 images	140 images
	STANDARD (STD)	980 images	205 images
128MB (optional)	SUPER FINE (SFN)	650 images	140 images
	FINE (FINE)	1310 images	280 images
	STANDARD (STD)	1970 images	415 images

Approximate time of moving pictures you can record on a “Memory Stick”

The time of moving pictures you can record varies depending on which image size you select and the complexity of the subject.

Type	160 × 112	320 × 240
4MB (optional)	2 min. 40 sec.	40 sec.
8MB (supplied)	5 min. 20 sec.	1 min. 20 sec.
16MB (optional)	10 min. 40 sec.	2 min. 40 sec.
32MB (optional)	21 min. 20 sec.	5 min. 20 sec.
64MB (optional)	42 min. 40 sec.	10 min. 40 sec.
128MB (optional)	85 min. 20 sec.	21 min. 20 sec.

The table above shows approximate number and times of still images and moving pictures you can record on a “Memory Stick” formatted by your camcorder.

Recording still images on “Memory Stick”s – Memory Photo recording

You can record still images on “Memory Stick”s.

Before operation

Insert a “Memory Stick” into your camcorder.

- (1) Set the POWER switch to MEMORY. Make sure that the LOCK switch is set to the right (unlock) position.
 - (2) Keep pressing PHOTO lightly until the desired still image appears. The green ● mark stops flashing, then lights up. The brightness of the image and focus are adjusted, being targeted for the middle of the image and are fixed. Recording does not start yet.
 - (3) Press PHOTO deeper.
- The still image will be displayed after the shutter sounds.
Recording is complete when the bar scroll indicator disappears.
The image when you pressed PHOTO deeper will be recorded on the “Memory Stick.”

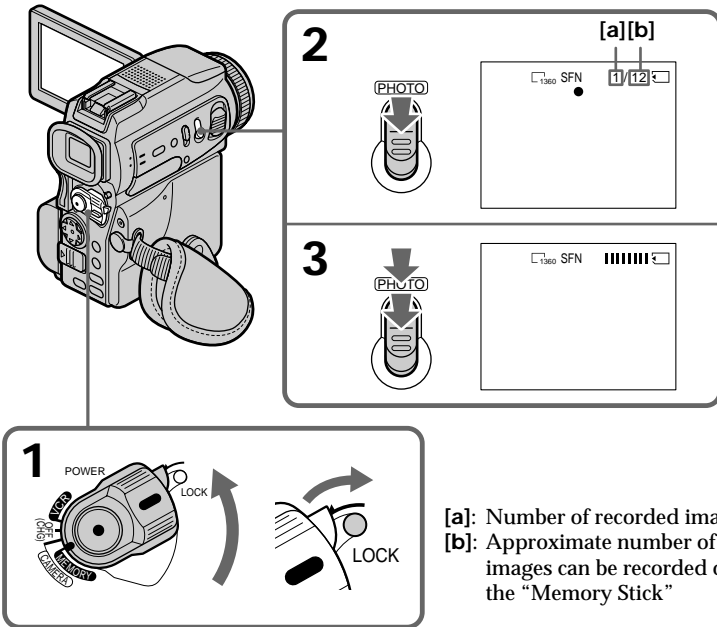

When the POWER switch is set to MEMORY

The following functions do not work:

- Wide mode
- Digital zoom
- SteadyShot function
- SUPER NIGHTSHOT
- Fader
- Picture effect
- Digital effect
- Title
- Low lux of PROGRAM AE (The indicator flashes.)
- Sports lesson of PROGRAM AE (The indicator flashes.)

Recording still images on “Memory Stick” - Memory Photo recording

While you are recording a still image
You can neither turn off the power nor press PHOTO.

When you press PHOTO on the Remote Commander
Your camcorder immediately records the image that is on the screen when you press the button.

When you press PHOTO lightly in step 2
The image momentarily flickers. This is not a malfunction.

Recording data

The recording data (date/time or various settings when recorded) are not displayed while recording. However, they are recorded automatically onto the “Memory Stick.” To display the recording data, press DATA CODE on the Remote Commander during playback.

When POWER switch is set to MEMORY

The angle of view is slightly larger compared with the angle of view in CAMERA mode.

Recording images continuously

You can record still images continuously. Select one of the three modes described below before recording.

NORMAL [a]

Your camcorder shoots up to three still images in 1360×1020 size or nine still images in 640×480 size at about 0.5 sec intervals. ()

HIGH SPEED (Recording image size is 640×480) [a]

Your camcorder shoots up to 16 still images in 640×480 size at about 0.07 sec intervals. ()

MULTI SCRN (Recording image size is 640×480) [b]

Your camcorder shoots nine still images at about 0.4 sec intervals and displays the images on a single page divided into nine boxes. Still images are recorded in 640×480 size. ()

[a]



[b]



Recording still images on “Memory Stick”s – Memory Photo recording

- (1) Set the POWER switch to MEMORY. Make sure that the LOCK switch is set to the right (unlock) position.
- (2) Press MENU, then select and decide upon STILL SET in  with the control button (p. 96).
- (3) Select and decide upon PIC MODE with the control button.
- (4) Select and decide upon the desired setting with the control button.
- (5) Press MENU to make the menu setting disappear.
- (6) Press PHOTO deeper.

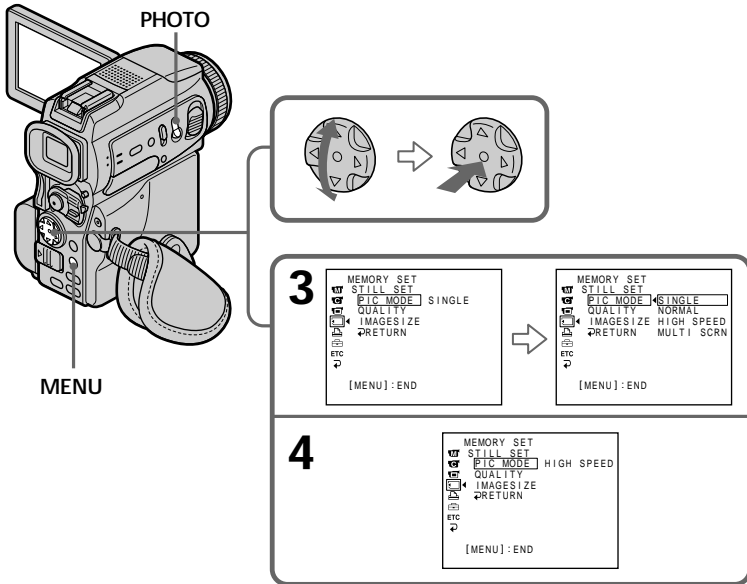

If the capacity of the “Memory Stick” becomes full

“ FULL” appears on the screen, and you cannot record a still image on this “Memory Stick.”

The number of images in continuous shooting

The number of images you can shoot continuously varies depending on the image size and the capacity of the “Memory Stick.”

During recording images continuously

The flash does not work.

When shooting with the self-timer function or the Remote Commander

Your camcorder automatically records up to the maximum recordable number of still images.

When selecting HIGH SPEED

Flickering or changes in color may occur. Also, your camcorder prevents focusing on near objects.

When selecting NORMAL or HIGH SPEED

Recording continues up to the maximum number of still images during pressing PHOTO deeper. Release PHOTO to stop recording.



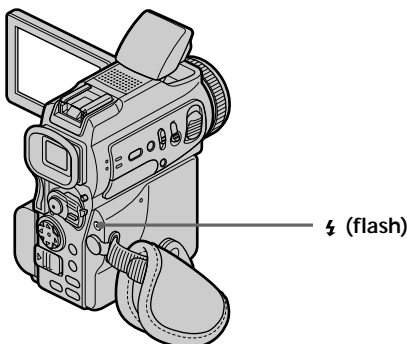

Recording still images on “Memory Stick”s – Memory Photo recording

Recording images with the flash

The flash automatically pops up to strobe. The default setting is auto (no indicator). To change the flash mode, press the  (flash) repeatedly until the flash mode indicator appears on the screen.



Each press of  (flash) changes the indicator as follows:

- →  →  → No indicator
- Auto red-eye reduction: The flash fires before recording to reduce the red-eye phenomenon.
-  Forced flash: The flash fires regardless of the surrounding brightness.
-  No flash: The flash does not fire.

The flash is adjusted to the appropriate brightness through the photocell window for the flash. You can also change FLASH LVL to the desired brightness in the menu settings (p. 96). Try recording various images to find the most appropriate setting for FLASH LVL.

Notes

- The recommended shooting distance using the built-in flash is 0.3 m to 2.5 m (31/32 feet to 8 1/3 feet).
- Attaching the lens hood (supplied) or a conversion lens (optional) may block the light from the flash or cause lens shadow to appear.
- You cannot use an external flash (optional) and the built-in flash at the same time.
-  (auto red-eye reduction) may not produce the desired effect depending on individual differences, the distance to the subject, the subject not looking at the pre-recording flash or other conditions.
- The flash effect cannot be obtained easily when you use forced flash in a bright location.
- If it is not easy to focus on a subject automatically, for example, when recording in the dark, use the focal distance information (p. 53) for focusing manually.

If you leave your camcorder for five or more minutes after disconnecting the power source

Your camcorder returns to the default setting (auto).

The flash does not fire even if you select auto and  (auto red-eye reduction) during the following operations:

- NightShot
- Exposure
- Spotlight of PROGRAM AE
- Sunset & moon of PROGRAM AE
- Landscape of PROGRAM AE

When you use an external flash (optional) which does not have the auto red-eye reduction function

You cannot select the auto red-eye reduction.

Recording still images on “Memory Stick”s – Memory Photo recording

Shooting using the HOLOGRAM AF

The HOLOGRAM AF is an auxiliary light source used for focusing on subjects in dark places.

Set HOLOGRAM F to AUTO in the menu settings. (The default setting is AUTO.)

When **☾on** appears on the screen in a dark place, press PHOTO lightly. Then the flash will pop up and the auxiliary light will automatically emit until the subject is focused.

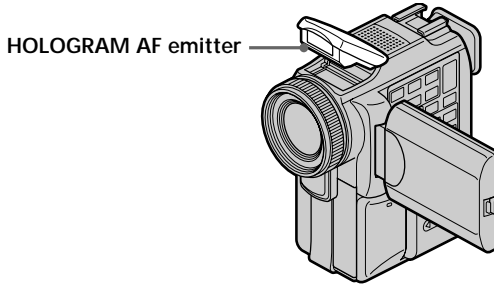

About HOLOGRAM AF

“HOLOGRAM AF (Auto-Focus),” an application of laser holograms, is a new AF optical system that enables still image shooting in dark places. Having gentler radiation than conventional high-brightness LEDs or lamps, the system satisfies Laser Class 1 (*) specification and thus maintains higher safety for human eyes.

No safety problems will be caused by directly looking into the HOLOGRAM AF emitter at a close range. However, it is not recommended to do so, because you may experience such effects like several minutes of image residual and dazzling, that you encounter after looking into a flashlight.

*HOLOGRAM AF satisfies Class 1 (time base 30,000 seconds), specified in all of JIS (Japan), IEC (EU), and FDA (US) industry standards.

Complying with these standards identifies the laser product to be safe, under a condition that a human looks at the laser light either directly or even through a lens for 30,000 seconds.

Notes

- If enough light does not reach the subject even if the HOLOGRAM AF emitter is emitted (recommended shooting distance is 2.5 m (8 1/3 feet)), the subject will not be focused.
- Focus is achieved as long as HOLOGRAM AF light reaches to the subject even if its light is slightly out of the middle position of the subject.
- If HOLOGRAM AF light is dim, it sometimes becomes difficult to focus. If this happens, wipe the HOLOGRAM AF emitter with a soft, dry cloth.

The HOLOGRAM AF does not emit when:

- Flash is set to **☾** No flash
- NightShot is set to ON
- focusing manually
- Sunset & moon of PROGRAM AE
- Landscape of PROGRAM AE



When you use the external flash (optional)

The built-in flash pops up and HOLOGRAM AF emit.

Recording still images on “Memory Stick” - Memory Photo recording

Self-timer memory photo recording

You can record images on “Memory Stick”[™]s with the self-timer. You can also use the Remote Commander for this operation.

- (1) Set the POWER switch to MEMORY. Make sure that the LOCK switch is set to the right (unlock) position.
- (2) Press  (self-timer). The  (self-timer) indicator appears on the screen.
- (3) Press PHOTO deeper.

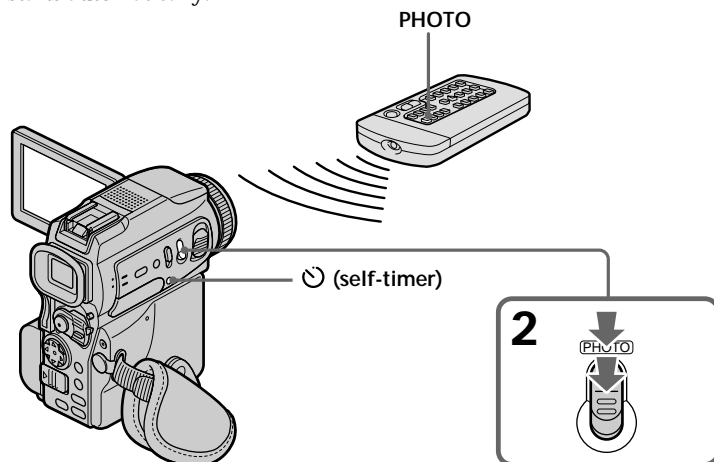

Self-timer starts counting down from 10 with a beep sound. In the last two seconds of the countdown, the beep sound gets faster, then recording starts automatically.



To record moving pictures on “Memory Stick”[™]s with the self-timer

Press START/STOP in step 3. To cancel recording, press START/STOP again.

To cancel self-timer recording

Press  (self-timer) so that the  (self-timer) indicator disappears on the screen. You cannot cancel the self-timer recording using the Remote Commander.

Note

The self-timer recording mode is automatically canceled when:

- Self-timer recording is finished.
- The POWER switch is set to OFF (CHG) or VCR.

To check the image to be recorded

You can check the image with pressing the PHOTO button lightly, then press it deeper to start the self-timer recording.

Recording an image from a tape as a still image

Your camcorder can read moving picture data recorded on a tape and record it as a still image on a “Memory Stick.” Your camcorder can also take in moving picture data through the input connector and record it as a still image on a “Memory Stick.”

Before operation

- Insert a recorded tape into your camcorder.
- Insert a “Memory Stick” into your camcorder.

- (1) Set the POWER switch to VCR.
- (2) Press **▶**. The picture recorded on the tape is played back.
- (3) Keep pressing **PHOTO** lightly until the picture from the tape freezes. **CAPTURE** appears on the screen. Recording does not start yet.
- (4) Press **PHOTO** deeper. The image displayed on the screen will be recorded on a “Memory Stick.” Recording is complete when the bar scroll indicator disappears.

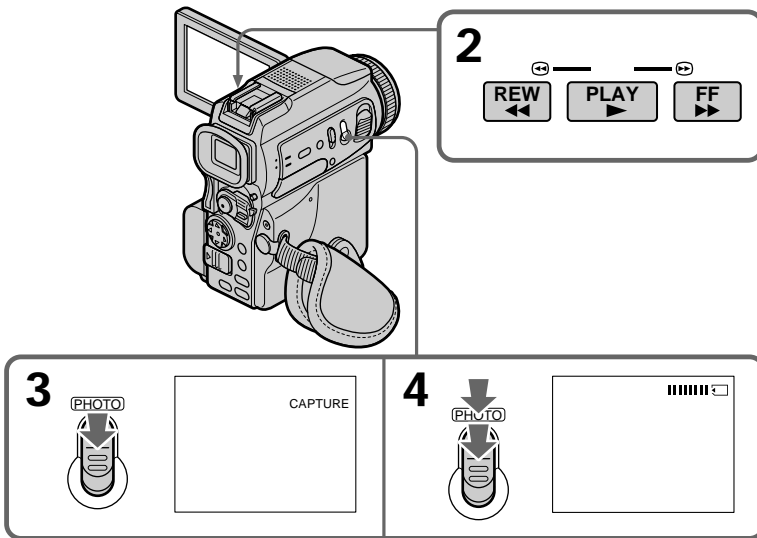

Image size of still images

Image size is automatically set to 640 × 480.

When the access lamp is lit or flashing

Do not shake or strike the unit. As well do not turn the power off, eject a “Memory Stick.” Otherwise, the image data breakdown may occur.

If “” appears on the screen

The inserted “Memory Stick” is incompatible with your camcorder because its format does not conform with your camcorder. Check the format of the “Memory Stick.”

If you press **PHOTO** lightly in the playback mode

Your camcorder stops momentarily.

Recording an image from a tape as a still image

Sound recorded on a tape

You cannot record the audio from a tape.

Titles have already recorded on tapes

You cannot record the titles on “Memory Stick”s. The title does not appear while you are recording a still image with PHOTO.

Recording date/time

The recording data (date/time) when it is recorded on “Memory Stick” is recorded. Various settings are not recorded.

When you press PHOTO on the Remote Commander

Your camcorder immediately records the image that is on the screen when you press the button.

Recording a still image from other equipment

Before operation

Set DISPLAY to LCD in the menu settings. (The default setting is LCD.)

- (1) Set the POWER switch to VCR.
- (2) Play back the recorded tape, or turn the TV on to see the desired program. The image of the other equipment is displayed on the LCD screen or viewfinder.
- (3) Follow steps 3 and 4 on page 118.

Using the A/V connecting cable

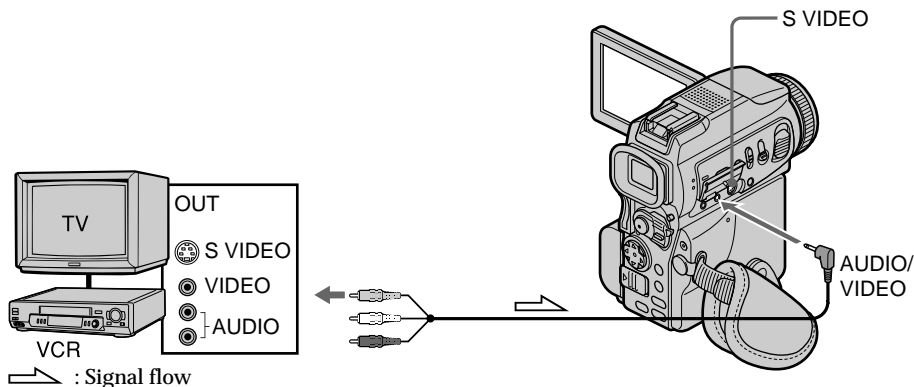

Connect the yellow plug of the A/V connecting cable to the video jack on the VCR or the TV.

If your TV or VCR has an S video jack

Pictures can be reproduced more faithfully by using an S video cable (optional).

With this connection, you do not need to connect the yellow (video) plug of the A/V connecting cable.

Connect an S video cable (optional) to the S video jacks of both your camcorder and the TV or VCR.

This connection produces higher quality DV format pictures.

Recording an image from a tape as a still image

Using the i.LINK cable (DV connecting cable)

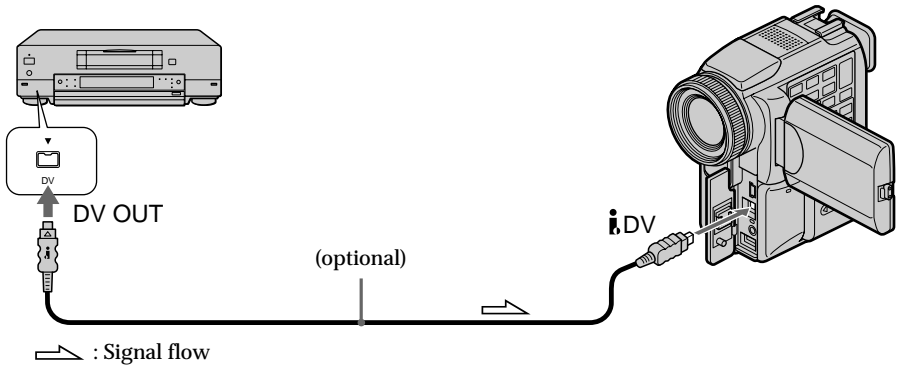

Note

The "⏏" may flash in the following instances. If this happens, eject and insert "Memory Stick" again, and record distortion-free images.

- When recording on a tape in a poor recording state, for example, on a tape that has been repeatedly used for dubbing
- When attempting to input images that are distorted due to poor radio wave reception when a TV tuner unit is in use

Superimposing a still image in the “Memory Stick” on an image

- MEMORY MIX

You can superimpose a still image you have recorded on the “Memory Stick” on top of the moving image you are recording. You can record the superimposed images on a tape or a “Memory Stick.” (However, you can record only superimposed still images on the “Memory Stick.”)

M. CHROM (Memory chromakey)

You can swap a blue area of a still image such as an illustration or a frame with a moving image.

M. LUMI (Memory luminancekey)

You can swap a brighter area of a still image such as a handwritten illustration or title with a moving image. Record a title on the “Memory Stick” before a trip or event for convenience.

C. CHROM (Camera chromakey)

You can superimpose a moving image on top of a still image such as an image can be used as background. Shoot the subject against a blue background. The blue area of the moving image will be swapped with a still image.

M. OVERLAP* (Memory overlap)

You can make a moving image fade in on top of a still image recorded on the “Memory Stick” as the overlap function.

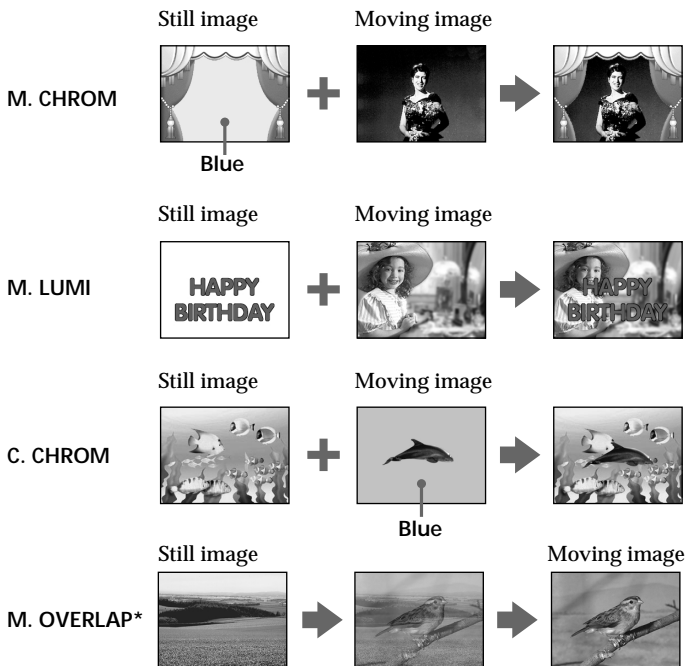

* The superimposed image using Memory overlap function can be recorded on tapes only.

Superimposing a still image in the “Memory Stick” on an image - MEMORY MIX

Recording superimposed images on a tape

Before operation

- Insert a tape for recording into your camcorder.
- Insert a “Memory Stick” recorded still images into your camcorder.

- (1) Set the POWER switch to CAMERA.
- (2) Press MEMORY MIX in the standby mode.
The last recorded or last composed image appears on the lower part of the screen as a thumbnail image.
- (3) Press MEMORY+/- to select the still image you want to superimpose.
To see the previous image, press MEMORY -. To see the next image, press MEMORY+.
- (4) Select the desired mode with the control button.
The mode changes as follows:
M. CHROM ↔ M. LUMI ↔ C. CHROM ↔ M. OVERLAP
- (5) Press ● on the control button.
The still image is superimposed on the moving image.
- (6) Press ◀/▶ on the control button to adjust the effect.

- M. CHROM – The color (blue) scheme of the area in the still image which is to be swapped with a moving image
- M. LUMI – The color (bright) scheme of the area in the still image which is to be swapped with a moving image
- C. CHROM – The color (blue) scheme of the area in the moving image which is to be swapped with a still image
- M. OVERLAP – No adjustment necessary

The fewer bars there are on the screen, the stronger the effect.

- (7) Press START/STOP to start recording.

Superimposing a still image in the “Memory Stick” on an image - MEMORY MIX

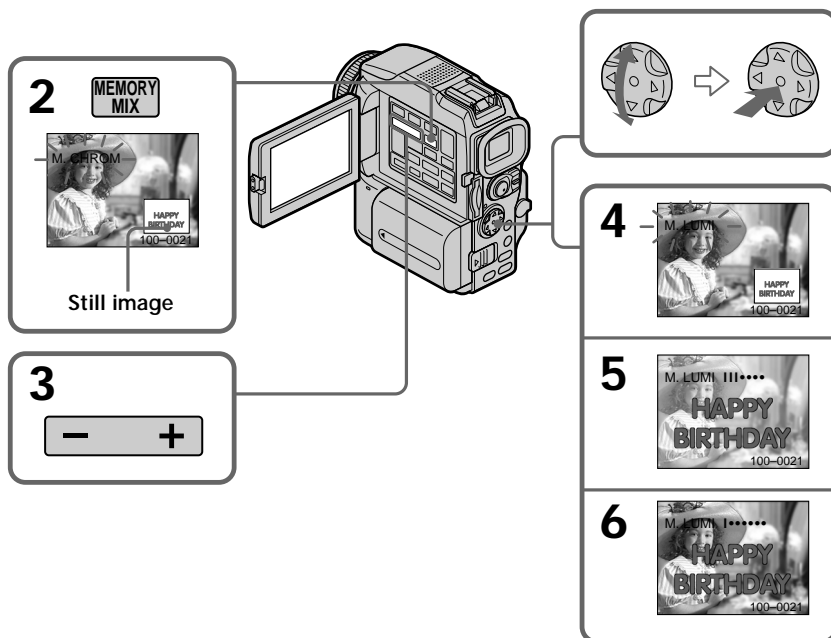

To change the still image to superimpose

Do either of the following:

- Press MEMORY+/- before step 7.
- Press ● on the control button before step 7, and repeat the procedure from step 4.

To change the mode setting

Press ● on the control button before step 7, and repeat the procedure from step 4.

To cancel MEMORY MIX

Press MEMORY MIX.

Notes

- You cannot use MEMORY MIX function for moving pictures recorded on “Memory Stick”s.
- When the overlapping still image has a large amount of white, the thumbnail image of the picture may not be clear.

Image data modified with your computers or shot with other equipment

You may not be able to play them back with your camcorder.

When you select M. OVERLAP

You cannot change the still image or the mode setting.

During recording

You cannot change the mode setting.

To record the superimposed image as a still image

Press PHOTO deeper in step 7.

Recording superimposed images on a “Memory Stick” as a still image

Before operation

Insert a “Memory Stick” recorded still images into your camcorder.

(1) Set the POWER switch to MEMORY. Make sure that the LOCK switch is set to the right (unlock) position.

(2) Press MEMORY MIX.

The last recorded or last composed image appears on the lower part of the screen as a thumbnail image.

(3) Press MEMORY+/- to select the image you want to superimpose.

To see the previous image, press MEMORY -. To see the next image, press MEMORY+.

(4) Select the desired mode with the control button.

The mode changes as follows:

M. CHROM ↔ M. LUMI ↔ C. CHROM

(5) Press ● on the control button.

The still image is superimposed on the moving image.

(6) Press ◀/▶ on the control button to adjust the effect.

M. CHROM – The color (blue) scheme of the area in the still image which is to be swapped with a moving image

M. LUMI – The color (bright) scheme of the area in the still image which is to be swapped with a moving image

C. CHROM – The color (blue) scheme of the area in the moving image which is to be swapped with a still image

The fewer bars there are on the screen, the stronger the effect.

(7) Press PHOTO deeper to start recording.

The image displayed on the screen will be recorded on a “Memory Stick.” Recording is complete when the bar scroll indicator disappears.

Superimposing a still image in the "Memory Stick" on an image - MEMORY MIX

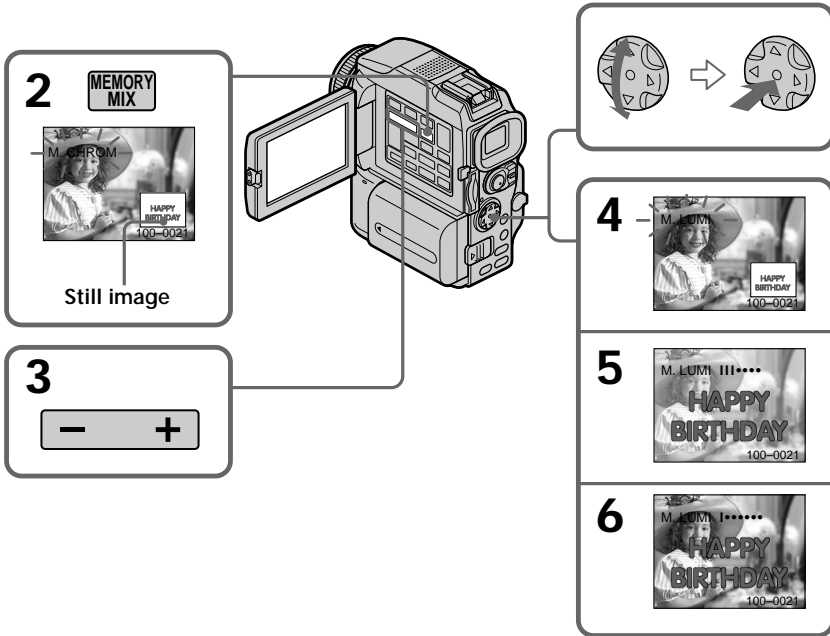

To change the still image to superimpose

Do either of the following:

- Press MEMORY+/- before step 7.
- Press ● on the control button before step 7, and repeat the procedure from step 4.

To change the mode setting

Press ● on the control button before step 7, and repeat the procedure from step 4.

To cancel MEMORY MIX

Press MEMORY MIX.

Notes

- You cannot use MEMORY MIX function for moving pictures recorded on "Memory Stick"s.
- When the overlapping still image has a large amount of white, the thumbnail image of the picture may not be clear.

Image data modified with your computers or shot with other equipment

You may not be able to play them back with your camcorder.

During recording

You cannot change the mode setting.

When recording images on a "Memory Stick" using the MEMORY MIX function

The PROGRAM AE function does not work. (The indicator flashes.)

The "Memory Stick" supplied with your camcorder stores 20 images

- For M. CHROM: 18 images (such as a frame) 100-0001~100-0018
- For C. CHROM: two images (such as a background) 100-0019~100-0020

Sample images

Sample images stored in the "Memory Stick" supplied with your camcorder are protected (p. 150).

Recording moving pictures on “Memory Stick”s – MPEG movie recording

You can record moving pictures with sound on “Memory Stick”s.

Before operation

Insert a “Memory Stick” into your camcorder.

- (1) Set the POWER switch to MEMORY. Make sure that the LOCK switch is set to the right (unlock) position.
- (2) Press START/STOP. Your camcorder starts recording. The camera recording lamp located on the front of your camcorder lights up. When IMAGESIZE in the menu settings is set to 320×240 , the maximum recording time is 15 seconds. However, when IMAGESIZE in the menu settings is set to 160×112 , the maximum recording time is 60 seconds.

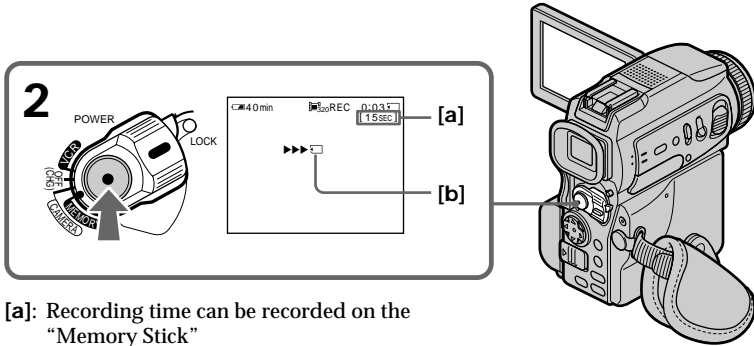

- [a]: Recording time can be recorded on the “Memory Stick”
- [b]: This indicator is displayed for five seconds after pressing START/STOP. This indicator is not recorded.

To stop recording

Press START/STOP.

Note

Sound is recorded in monaural.

When the POWER switch is set to MEMORY

The following functions do not work:

- Wide mode
- Digital zoom
- SteadyShot function
- SUPER NIGHTSHOT
- Fader
- Picture effect
- Digital effect
- Title
- Low lux of PROGRAM AE (The indicator flashes.)
- Sports lesson of PROGRAM AE (The indicator flashes.)

Recording moving pictures on “Memory Stick”s - MPEG movie recording

When using an external flash (optional)

Turn the power of the external flash off when recording moving pictures on “Memory Stick”s.

Otherwise, the charging sound for the flash may be recorded.

Recording date/time

The date/time are not displayed while recording. However, they are automatically recorded onto the “Memory Stick.”

To display the recording date/time, press DATA CODE on the Remote Commander during playback. Various settings cannot be recorded.

During recording on “Memory Stick”

Do not eject the cassette tape from your camcorder. During ejecting the tape, sound is not recorded on the “Memory Stick.”

When the POWER switch is set to MEMORY

The angle of view is slightly larger compared with the angle of view in CAMERA mode.

Recording a picture from a tape as a moving picture

Your camcorder can read moving picture data recorded on a tape and record it as a moving picture on a “Memory Stick.” Your camcorder can also take in moving picture data through the input connector and record it as a moving picture on a “Memory Stick.”

Before operation

- Insert a recorded tape into your camcorder.
- Insert a “Memory Stick” into your camcorder.

- (1) Set the POWER switch to VCR.
- (2) Press ►. The picture recorded on the tape is played back.
And press || at the scene where you want to start recording from.
- (3) Press START/STOP on your camcorder. When IMAGESIZE in the menu settings is set to 320×240 , the maximum recording time is 15 seconds.
However, when IMAGESIZE in the menu settings is set to 160×112 , the maximum recording time is 60 seconds.

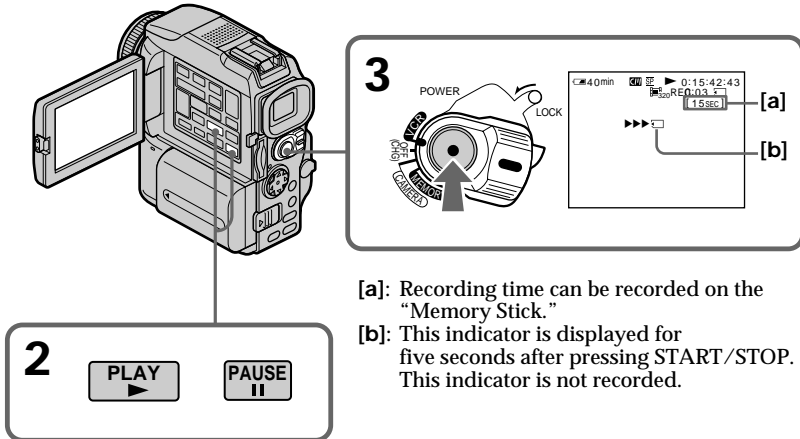

[a]: Recording time can be recorded on the “Memory Stick.”

[b]: This indicator is displayed for five seconds after pressing START/STOP. This indicator is not recorded.

To stop recording

Press START/STOP.

Recording a picture from a tape as a moving picture

Notes

- Sound recorded in 48 kHz is converted to one in 32 kHz when recording images from a tape to “Memory Stick”s.
- Sound recorded in stereo is converted to monaural sound when recording from tapes.

When the access lamp is lit or flashing

Do not shake or strike the unit. As well do not turn the power off, eject a “Memory Stick” or remove the battery pack. Otherwise, the image data breakdown may occur.

Titles have already recorded on tapes

You cannot record the titles on “Memory Stick”s. The title does not appear while you are recording a moving image with START/STOP.

If “ AUDIO ERROR” is displayed

Sound that cannot be recorded by your camcorder has been recorded. Connect the A/V connecting cable to input images from an external unit used to play back the image (p. 130).

Recording date/time

The recording data (date/time) when it is recorded on “Memory Stick” is recorded. Various settings are not recorded.

Recording a picture from a tape as a moving picture

Recording a moving picture from other equipment

Before operation

Set DISPLAY to LCD in the menu settings. (The default setting is LCD.)

- (1) Set the POWER switch to VCR.
- (2) Play back the recorded tape, or turn the TV on to see the desired program.
The image of the other equipment is displayed on the LCD screen or viewfinder.
- (3) Follow the procedure on page 128 from the step 3 onwards at the point where you want to start recording from.

Using the A/V connecting cable

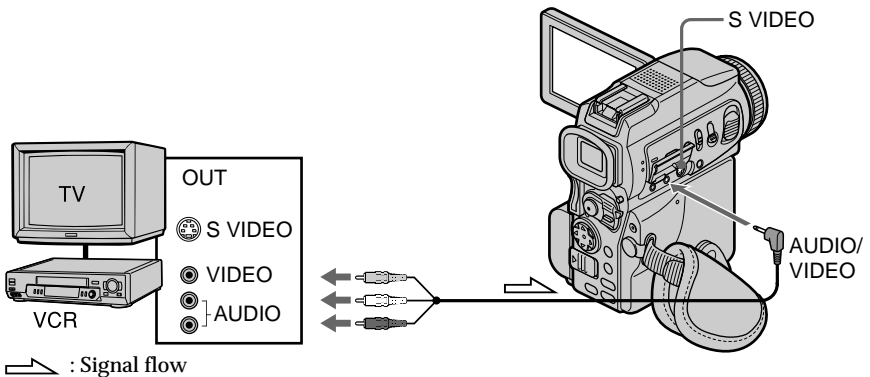

Connect the yellow plug of the A/V connecting cable to the video jack on the VCR or the TV.

If your TV or VCR has an S video jack

Pictures can be reproduced more faithfully by using an S video cable (optional).

With this connection, you do not need to connect the yellow (video) plug of the A/V connecting cable.

Connect an S video cable (optional) to the S video jacks of both your camcorder and the TV or VCR.

This connection produces higher quality DV format pictures.

Recording a picture from a tape as a moving picture

Using the i.LINK cable (DV connecting cable)

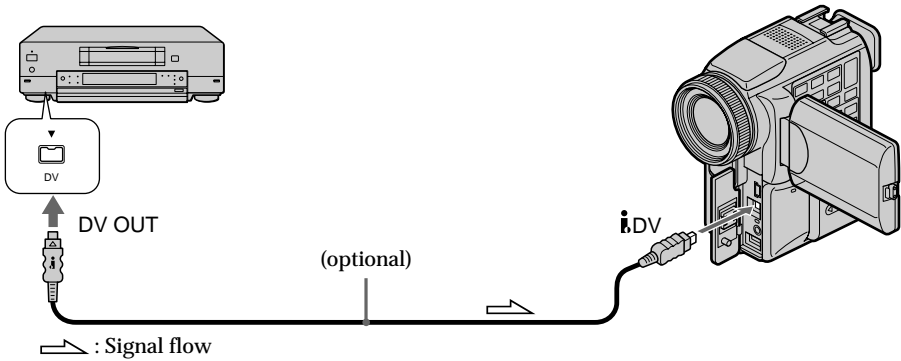

Note

The “” may flash in the following instances. If this happens, eject and insert “Memory Stick” again, and record distortion-free images.

- When recording on a tape in a poor recording state, for example, on a tape that has been repeatedly used for dubbing
- When attempting to input images that are distorted due to poor radio wave reception when a TV tuner unit is in use

During recording on “Memory Stick”

Do not eject the cassette tape from your camcorder. During ejecting the tape, sound is not recorded on the “Memory Stick.”

Recording edited pictures as a moving picture – Digital program editing (on “Memory Stick”s)

You can duplicate selected scenes (programs) for editing onto “Memory Stick”s.

Making the program

- (1) Set the POWER switch to VCR on your camcorder.
- (2) Insert the tape for playback, and a “Memory Stick” for recording into your camcorder.
- (3) Press MENU, then select and decide upon VIDEO EDIT in  with the control button (p. 96).
- (4) Select and decide upon MEMORY with the control button.
- (5) Select and decide upon IMAGE SIZE with the control button.
When IMAGE SIZE is set to 320 × 240, the maximum recording time is 15 seconds. However, when IMAGE SIZE is set to 160 × 112, the maximum recording time is 60 seconds.
- (6) Search for the beginning of the first scene you want to insert using the video operation buttons, then pause playback.
You can fine-adjust one frame at a time with EDITSEARCH.
- (7) Press MARK on the Remote Commander, or ● on the control button.
The IN point of the first program is set, and the top part of the program mark changes to light blue.
- (8) Search for the end of the first scene you want to insert using the video operation buttons, then pause playback.
- (9) Press MARK on the Remote Commander, or ● on the control button.
The OUT point of the first program is set, then the bottom part of the program mark changes to light blue.
- (10) Repeat steps 6 to 9, then set the program.
When one program is set, the program mark changes to light blue.
You can set 20 programs in maximum.

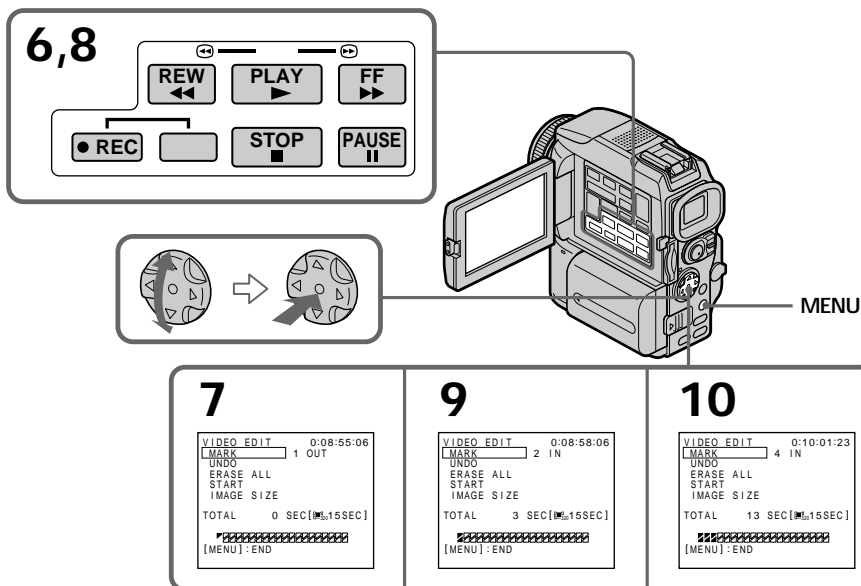

Recording edited pictures as a moving picture – Digital program editing (on “Memory Stick”s)

Erasing the program you have set

Erase OUT first and then IN from of the last program.

- (1) Select and decide upon UNDO with the control button.
- (2) Select and decide upon EXECUTE with the control button.
The last set program mark flashes, then the setting is canceled.

To cancel erasing

Select and decide upon RETURN with the control button in step 2.

Erasing all programs

- (1) Select and decide upon VIDEO EDIT, then select and decide upon MEMORY with the control button.
- (2) Select and decide upon ERASE ALL, then select and decide upon EXECUTE with the control button.
All the program marks flash, then the settings are canceled.

To cancel erasing all programs

Select and decide upon RETURN with the control button in step 2.

To cancel a program you have set

Press MENU.

The program is stored in memory until the tape is ejected.

Notes

- You cannot dub the titles, display indicators, or the contents of cassette memory.
- You cannot operate recording during the digital program editing on “Memory Stick”s.
- You cannot set IN or OUT on a blank portion of the tape.
- If there is a blank portion between IN and OUT on the tape, the total time code may not be displayed correctly.

During making a program

If you eject the cassette, NOT READY appears on the screen. The program will be erased.

If you set over the maximum recording time

The program mark changes to yellow, and OVER 15 SEC LIMIT appears when IMAGE SIZE is set to 320×240 , or OVER 60 SEC LIMIT appears when IMAGE SIZE is set to 160×112 . However, you can record up to the maximum recording time.

Performing the program (Dubbing a “Memory Stick”)

- (1) Select and decide upon VIDEO EDIT in the menu settings, then select and decide upon MEMORY with the control button.
- (2) Select and decide upon START, then select and decide upon EXECUTE with the control button.
Search for the beginning of the first program, then start dubbing.
The program mark flashes.
The SEARCH indicator appears during search, the EDITING indicator appears during writing of data on your camcorder, and REC appears during dubbing on the screen.
The PROGRAM indicator changes to light blue after dubbing is complete.
When the dubbing ends, your camcorder automatically stops.

To stop dubbing during editing

Press ■ using the video operation buttons.

The program you made is recorded on a “Memory Stick” up to the place where you pressed ■.

Recording edited pictures as a moving picture - Digital program editing (on "Memory Stick"s)

To end the Digital program editing function

Your camcorder stops when the dubbing ends. Then the display returns to VIDEO EDIT in the menu settings.

Press MENU to end the program editing function.

NOT READY appears on the LCD screen when:

- The program to operate the Digital program editing has not been made.
- The "Memory Stick" is not inserted.
- The write-protect tab on the "Memory Stick" is set to LOCK.
- "Memory Stick" does not have enough space to record

When "Memory Stick" does not have enough space to record

LOW MEMORY appears on the screen. However, you can record pictures up to the time indicated.

If you set over the maximum recording time

OVER MEMORY LIMIT appears on the screen. However, you can record moving pictures up to the maximum recording time.

Copying still images from a tape – Photo save

Using the search function, you can automatically take in only still images from tapes and record them on a “Memory Stick” in sequence.

Before operation

- Insert a recorded tape into your camcorder and rewind the tape.
- Insert a “Memory Stick” into your camcorder.

- (1) Set the POWER switch to VCR.
- (2) Press MENU, then select and decide upon PHOTO SAVE in  with the control button (p. 96).
PHOTO BUTTON appears on the screen.
- (3) Press PHOTO deeper. The still image from the tape is recorded on a “Memory Stick.” The number of still images copied is displayed. END is displayed when copying is completed.

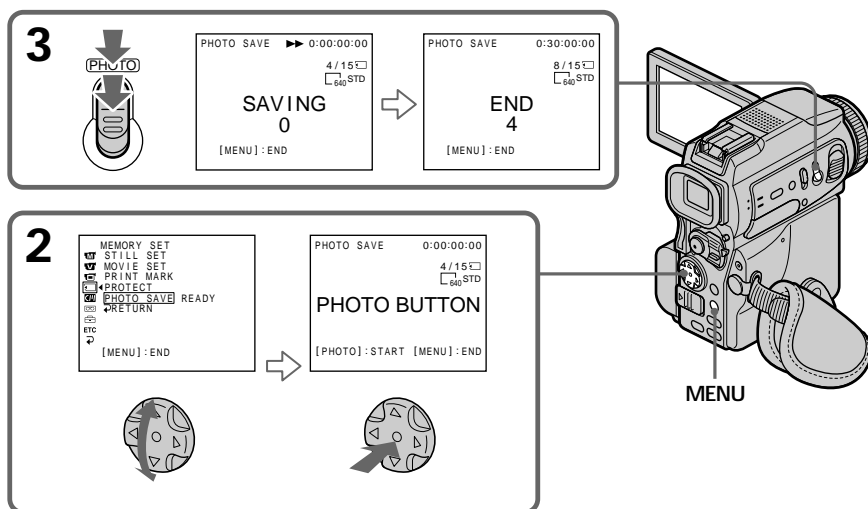

To stop copying

Press MENU.

When the memory of the “Memory Stick” is full

MEMORY FULL appears on the screen, and the copying stops. Insert another “Memory Stick” and repeat the procedure from step 2.

Image size of still images

Image size is automatically set to 640 × 480.

When the access lamp is lit or flashing

Do not shake or strike your camcorder. As well do not turn the power off, eject a “Memory Stick” or remove the battery pack. Otherwise, the image data breakdown may occur.

If the write-protect tab on the “Memory Stick” is set to LOCK

NOT READY appears when you select the item in the menu settings.

When you change “Memory Stick”s in the middle of copying

Your camcorder resumes copying from the last image recorded on the previous “Memory Stick.”

Viewing a still image – Memory photo playback

You can play back still images recorded on a “Memory Stick.” You can also play back six images including moving pictures in order at a time by selecting the index screen.

Before operation

Insert a “Memory Stick” into your camcorder.

- (1) Set the POWER switch to MEMORY or VCR. Make sure that the LOCK switch is set to the right (unlock) position.
- (2) Press MEMORY PLAY. The last recorded image is displayed.
- (3) Press MEMORY +/- to select the desired still image. To see the previous image, press MEMORY -. To see the next image, press MEMORY +.

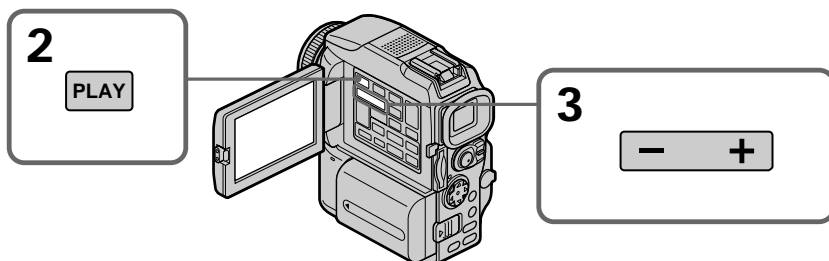

To stop memory photo playback

Press MEMORY PLAY.

Note

You may not be able to play back images with your camcorder:

- when playing back image data modified on your computers.
- when playing back image data shot with other equipment.

Notes on the file name

- The directory number may not be displayed and only the file name may be displayed if the structure of the directory does not conform to the DCF standard.
- “ DIRECTORY ERROR” may appear on the screen if the structure of the directory does not conform to the DCF standard. While this message appears, you can play back images but cannot record them on the “Memory Stick.”
- The file name flashes on the screen if the file is corrupted or the file is unreadable.

To play back recorded images on a TV screen

- Connect your camcorder to the TV with the A/V connecting cable supplied with your camcorder before operation.
- When operating memory photo playback on a TV or on the LCD screen, the image quality may appear to have deteriorated. This is not a malfunction. The image data is as good as ever.
- Turn the audio volume of the TV down before operation, or noise (howling) may be output from the TV speakers.

When no image is recorded on the “Memory Stick”

The message “ NO FILE” appears.

Viewing a still image - Memory photo playback

Screen indicators during still image playback

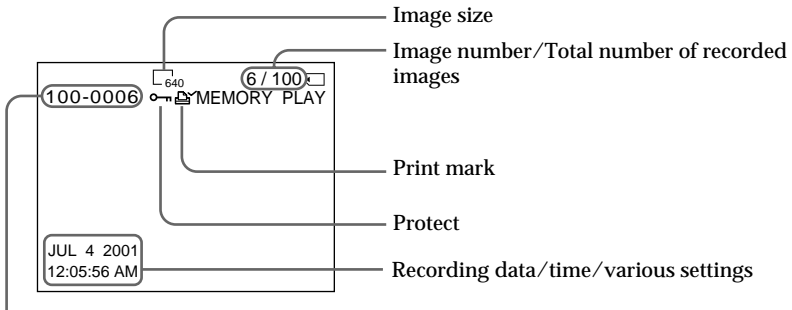

Data Directory Number, File Number

Recording data

When you press DATA CODE on the Remote Commander, you can see the recording data (date/time or various settings when recorded).

Viewing a still image – Memory photo playback

Playing back six recorded images at a time (index screen)

You can play back six recorded images at a time. This function is especially useful when searching for a particular image.

- (1) Set the POWER switch to MEMORY or VCR. Make sure that the LOCK switch is set to the right (unlock) position.
- (2) Press MEMORY INDEX to display the index screen.

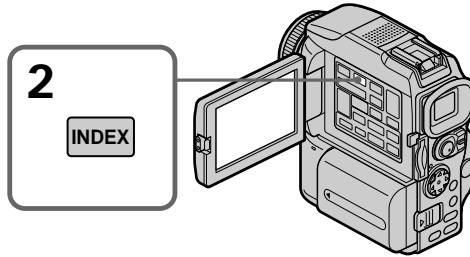

A red ► mark appears above the image that is displayed before changing to the index screen mode.

MEMORY - : to display the previous six images

MEMORY + : to display the following six images

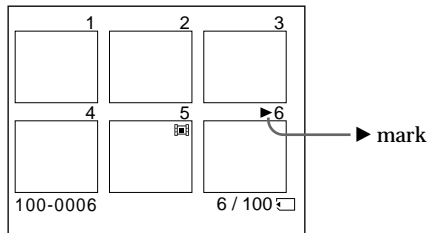

To return to the normal playback screen (single screen)

Press MEMORY +/- to move the ► mark to the image you want to display on full screen, then press MEMORY PLAY.

Note

When displaying the index screen, the number appears above each image. This indicates the order in which images are recorded on the "Memory Stick." These numbers are different from the data file names (p. 104).

Image data modified with your computers or shot with other equipment

These files may not be displayed on the index screen.

Viewing a moving picture – MPEG movie playback

You can play back moving pictures recorded on a “Memory Stick.” You can also play back six images including still images in order at a time by selecting the index screen.

Before operation

Insert a “Memory Stick” into your camcorder.

- (1) Set the POWER switch to MEMORY or VCR. Make sure that the LOCK switch is set to the right (unlock) position.
- (2) Press MEMORY PLAY. The last recorded image is displayed.
- (3) Press MEMORY +/- to select the desired moving pictures. To see the previous picture, press MEMORY -. To see the next picture, press MEMORY +.
- (4) Press MPEG ► || to start playback.

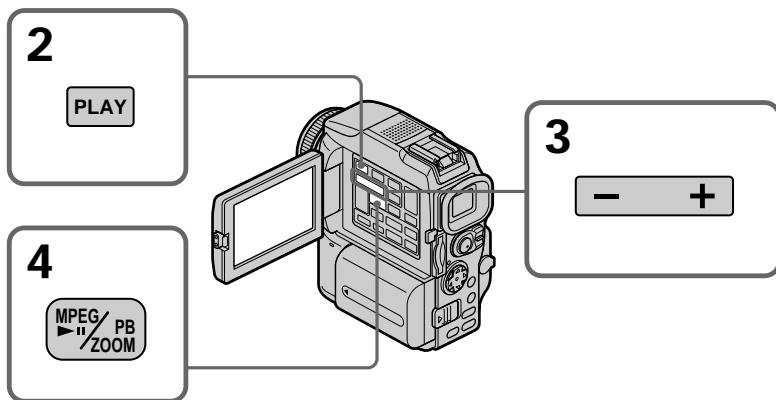

“Memory Stick” Operations

To stop MPEG movie playback

Press MEMORY PLAY.

Note

You may not be able to play back images with your camcorder:

- when playing back image data modified on your computers.
- when playing back image data shot with other equipment.

To play back recorded images on a TV screen

- Connect your camcorder to the TV with the A/V connecting cable supplied with your camcorder before operation.
- Turn the audio volume of the TV down before operation, or noise (howling) may be output from the TV speakers.

When no image is recorded on the “Memory Stick”

The message “ NO FILE” appears.

Viewing a moving picture – MPEG movie playback

Screen indicators during moving picture playback

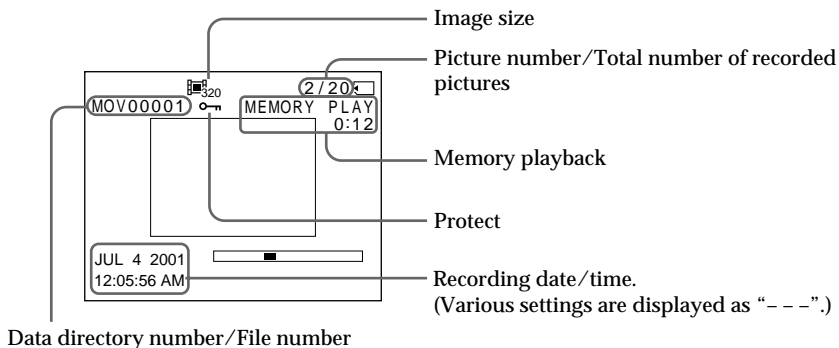

Recording date/time

To display the recording date/time, press DATA CODE on the Remote Commander during playback.

Viewing images using computer

You can view data recorded on the “Memory Stick” using your computer.

Note

Data recorded on the “Memory Stick” is stored in the following formats. Make sure that applications that support these file formats are installed on your computer.

- Still images: JPEG format
- Moving images/audio: MPEG format

Recommended computer environment

Recommended Windows environment

OS: Microsoft Windows 98, Windows 98SE, Windows Me or Windows 2000
Professional standard installation is required.

However, operation is not assured if the above environment is upgraded OS.

CPU: MMX Pentium 200 MHz or faster

The USB connector must be provided as standard.

An application such as RealPlayer or Windows Media Player capable of playing back MPEG picture must be installed (to play back moving pictures).

Recommended Macintosh environment

Macintosh computer with the Mac OS 8.5.1/8.6/9.0/9.1 or Mac OS X standard installation

However, note that the update to Mac OS 9.0/9.1 should be used for the following models.

- iMac with the Mac OS 8.6 standard installation and a slot loading type CD-ROM drive
- iBook or Power Mac G4 with the Mac OS 8.6 standard installation

The USB connector must be provided as standard.

QuickTime 3.0 or newer must be installed (to play back moving pictures).

Notes

- Operations are not guaranteed for either the Windows or Macintosh environment if you connect two or more USB equipment to a single computer at the same time, or when using a hub.
- Depending on the type of USB equipment that is used simultaneously, some equipment may not operate.
- Operations are not guaranteed for all the recommended computer environments mentioned above.
- All other product names mentioned herein may be the trademarks or registered trademarks of their respective companies. Furthermore, “™” and “®” are not mentioned in each case in this manual.

Viewing images using computer

Installing the USB driver

Before connecting your camcorder to your computer, install the USB driver to the computer. The USB driver is contained together with application software for viewing images on a CD-ROM which is supplied with your camcorder.

Do not connect the USB cable to your computer before installation of the USB driver is completed.

Example: For Windows 98/98SE/Me, Windows 2000 users

- (1) Turn on the power of your computer and allow Windows to load.
- (2) Insert the supplied CD-ROM in the CD-ROM drive of your computer. The application software screen appears.
- (3) Set the cursor on “USB Driver Installation for Windows 98/98SE/Me and Windows 2000” and click. USB driver installation starts.
- (4) Follow the on-screen messages to install the USB driver.
- (5) Connect the Ψ (USB) jack on your camcorder with the USB connector on your computer using the supplied USB cable.
- (6) Insert a “Memory Stick” into your camcorder, connect the AC power adaptor and set the POWER switch to MEMORY.
USB MODE appears on the LCD screen of your camcorder. Your computer recognizes the camcorder, and the Windows Add Hardware Wizard starts.
- (7) Follow the on-screen messages to have the Add Hardware Wizard recognize the hardware. The Add Hardware Wizard starts twice because two different USB drivers are installed. Be sure to allow the installation to complete without interrupting it.

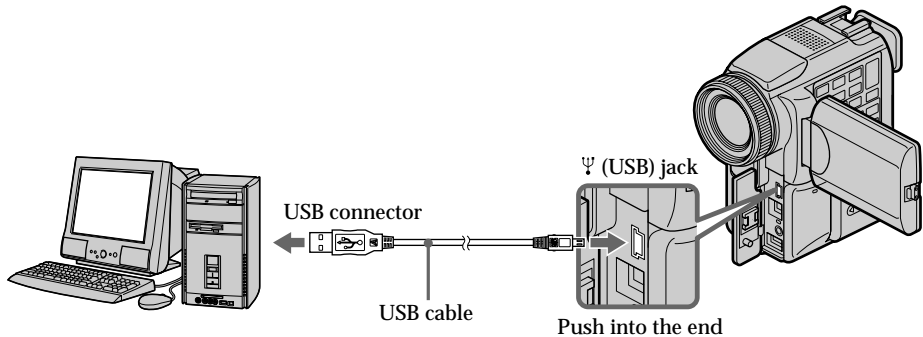

Notes

- You cannot install the USB driver if a “Memory Stick” is not in your camcorder. Be sure to insert a “Memory Stick” into your camcorder before installing the USB driver.
- The USB driver has been registered incorrectly as your computer was connected to your camcorder before installation of the USB driver was completed. Re-install the USB driver following the procedure on page 143.

Image data cannot be transferred by the USB connection

The USB driver has been registered incorrectly as your computer was connected to your camcorder before installation of the USB driver was completed. Perform the following procedure to correctly install the USB driver.

Step 1 Uninstall the incorrect USB driver

- ① Turn on the power and allow Windows to load.
- ② Connect the USB jack on your computer to the Ψ (USB) jack on your camcorder using the USB cable supplied with your camcorder.
- ③ Insert a "Memory Stick" into your camcorder, connect the AC power adaptor, and set the POWER switch to MEMORY.
- ④ Open your computer's "Device Manager".
Windows 2000 Professional:
Open "My Computer" → "Control Panel" → "Hardware" tab, and click the "Device Manager" button.
Other OS:
Select "My Computer" → "Control Panel" → "System", and click "Device Manager".
- ⑤ Select "Other devices".
Select the device prefixed with the "?" mark and delete.
Ex: (?)Sony Handycam
- ⑥ Set the POWER switch to OFF (CHG), and then disconnect the USB cable.
- ⑦ Restart your computer.

Step 2 Install the USB driver on the CD-ROM

Perform the entire procedure listed in "Installing the USB Driver" on the page 142.

Example: For Mac OS 8.5.1/8.6/9.0 users

- (1) Turn on the power of your computer and allow the Mac OS to load.
- (2) Insert the supplied CD-ROM in the CD-ROM drive of your computer.
- (3) Double-click the CD-ROM drive icon to open the window.
- (4) Double-click the icon of the hard disk containing the OS to open the window.
- (5) Move the following two files from the window opened in step 3 to the System Folder icon in the window opened in step 4 (drag and drop).
 - Sony Camcorder USB Driver
 - Sony Camcorder USB Shim
- (6) When "Put these items into the Extensions folder?" appears, click OK.
- (7) Restart your computer.

For Mac OS 9.1/Mac OS X

The USB driver need not be installed. Your Mac is automatically recognized as a driver just by connecting your Mac using the USB cable.

Viewing images using computer

Viewing images

For Windows users

- (1) Turn on the power of your computer and allow Windows to load.
- (2) Connect one end of USB cable to the Ψ (USB) jack on the camcorder and the other end to the USB connector on your computer.
- (3) Insert a “Memory Stick” into your camcorder, and connect the AC power adaptor to your camcorder and then to a wall outlet.
- (4) Set the POWER switch to MEMORY.
USB MODE appears on the screen of the camcorder.
- (5) Open “My Computer” on Windows and double click the newly recognized drive (Example: “Removable Disk (E:)”).
The folders inside the “Memory Stick” are displayed.
- (6) Select and double-click the desired image file from the folder.
For the detailed folder and file name, see “Image file storage destinations and image files” (p. 146).

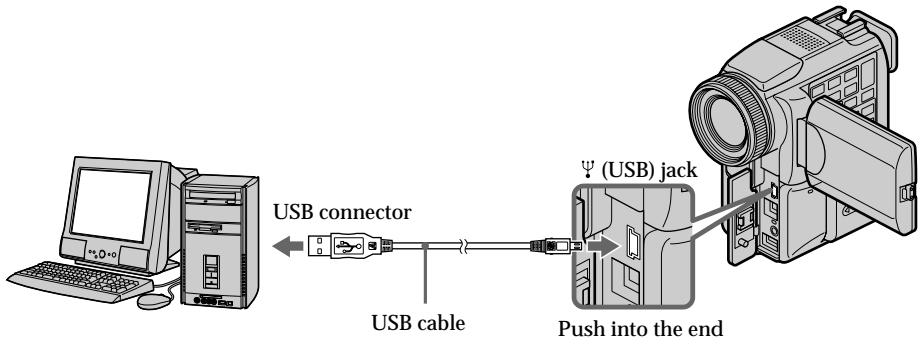

Desired file type	Double-click in this order
Still image	“Dcim” folder → “100msdcf” folder → Image file
Moving picture*	“Mssony” folder → “Moml0001” folder → Image file*

* Copying a file to the hard disk of your computer before viewing it is recommended. If you play back the file directly from the “Memory Stick,” the image and sound may break off.

Viewing images using computer

For Windows 2000 Professional/Me users

To unplug the USB cable or eject the “Memory Stick”, follow the procedure below.

- (1) Move the cursor to the “Unplug or Eject Hardware” icon on the Task Tray and click to cancel the applicable drive.
- (2) A message to remove the device from the system appears, then unplug the USB cable or eject the “Memory Stick.”

For Macintosh users

To unplug the USB cable or eject the “Memory Stick”, follow the procedure below.

- (1) Quit application programs opened.
Make sure that the access lamp of the hard disk is not lit.
- (2) Drag and drop the “Memory Stick” icon to the Trash or select Eject under the Special menu.
- (3) Unplug the USB cable or eject the “Memory Stick.”

For Mac OS X users

Unplug the USB cable or eject the “Memory Stick” after shutting down your computer.

Notes on using your computer

“Memory Stick”

- “Memory Stick” operations on your camcorder cannot be assured if a “Memory Stick” formatted on your computer is used on your camcorder, or if the “Memory Stick” in your camcorder was formatted from your computer when the USB cable was connected.
- Do not optimize the “Memory Stick” on a Windows machine. This will shorten the “Memory Stick” life.
- Do not compress the data on the “Memory Stick.” Compressed files cannot be played back on your camcorder.

Software

- Depending on your application software, the file size may increase when you open a still image file.
- When you load an image modified using a retouch software from your computer to the camcorder or when you directly modify the image on the camcorder, the image format will differ so a file error indicator may appear and you may be unable to open the file.

Communications with your computer

Communications between your camcorder and your computer may not recover after recovering from Suspend, Resume, or Sleep.

Viewing images using computer

Image file storage destinations and image files

Image files recorded with your camcorder are grouped in folders by recording mode. The meanings of the file names are as follows. □□□□ stands for any number within the range from 0001 to 9999.

For Windows Me users
(The drive recognizing the camera is [E:].)

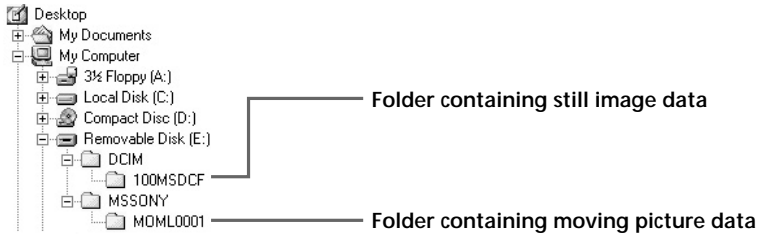

Folder	File	Meaning
100msdcf	DSC0□□□□.JPG	Still image file
Moml0001	MOV0□□□□.MPG	Moving picture file

Copying the image recorded on “Memory Stick”s to tapes

You can copy images recorded on “Memory Stick” and record them to a tape.

Before operation

- Insert a tape for recording into your camcorder.
- Insert a “Memory Stick” into your camcorder.

- (1) Set the POWER switch to VCR.
- (2) Using the video control buttons, search a point where you want to record the desired images. Set the tape to playback pause.
- (3) Press ● REC and the button on its right simultaneously on your camcorder. The tape is set to the recording pause mode.
- (4) Press MEMORY PLAY. The last recorded image is displayed.
- (5) Press MEMORY +/- to select the desired image. To see the previous image, press MEMORY -. To see the next, press MEMORY +.
- (6) Press ■ to start recording and press ■ again to stop.
 - appears on the screen during recording.
- (7) If you have more to copy, repeat steps 5 and 6.

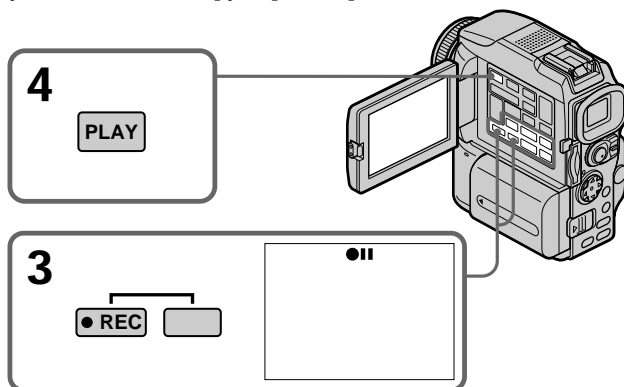

To stop copying in the middle

Press ■.

During copying

You cannot operate the following buttons:

- MEMORY PLAY
- MEMORY INDEX
- MEMORY DELETE
- MEMORY +/-
- MEMORY MIX

Note on the index screen

You cannot record the index screen.

If you press EDITSEARCH during pause mode

Memory playback stops.

Image data modified with your computers or shot with other equipment

You may not be able to copy them with your camcorder.

If you press DISPLAY in during recording or in recording standby mode

You can see memory playback and the file name indicators in addition to the indicators pertinent to tapes, such as the time code indicator.

Enlarging still images recorded on "Memory Stick"s – Memory PB ZOOM

You can enlarge still images recorded on a "Memory Stick." You can select and view the desired part from the enlarged still image. Also you can copy the desired part of the enlarged still image to tapes or "Memory Stick"s.

Before operation

Insert a "Memory Stick" into your camcorder.

- (1) Set the POWER switch to MEMORY or VCR. Make sure that the LOCK switch is set to the right (unlock) position.
- (2) In the memory playback mode, press PB ZOOM on your camcorder.
The center of the image is enlarged to twice its size.
- (3) Press the control button to move the image.
The image moves in the same direction as the control button.
- (4) Adjust the zoom ratio by the power zoom lever.
You can enlarge the image from 1.1 times up to five times its size.
W : Decreases the zoom ratio.
T : Increases the zoom ratio.

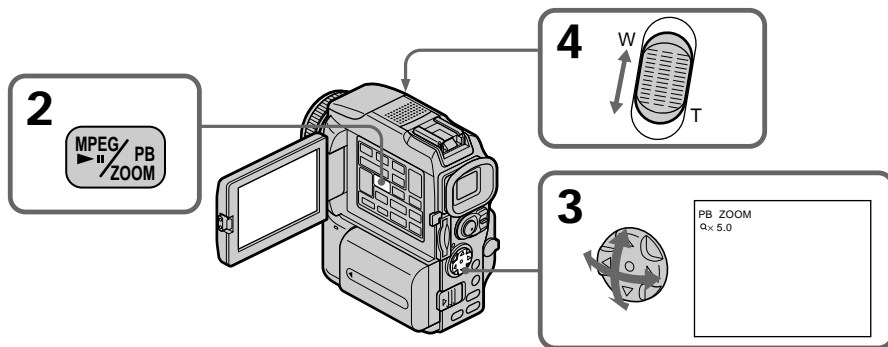

To cancel the PB ZOOM function

Press PB ZOOM.

In the PB ZOOM mode

The digital effect function does not work.

The PB ZOOM function is canceled when the following buttons are pressed:

- MENU
- MEMORY PLAY
- MEMORY INDEX
- MEMORY +/-

Moving pictures recorded on "Memory Stick"s

The PB ZOOM function does not work.

To record an image processed by PB ZOOM on "Memory Stick"s

Press the PHOTO button to record the image processed by PB ZOOM. (The image size becomes 640 × 480)

Playing back images in a continuous loop – SLIDE SHOW

You can automatically play back images in sequence. This function is useful especially when checking recorded images or during a presentation.

Before operation

Insert a “Memory Stick” into your camcorder.

- (1) Set the POWER switch to MEMORY. Make sure that the LOCK switch is set to the right (unlock) position.
- (2) Press MENU, then select and decide upon SLIDE SHOW in  with the control button (p. 96).
- (3) Press MEMORY PLAY. Your camcorder plays back the images recorded on a “Memory Stick” in sequence.

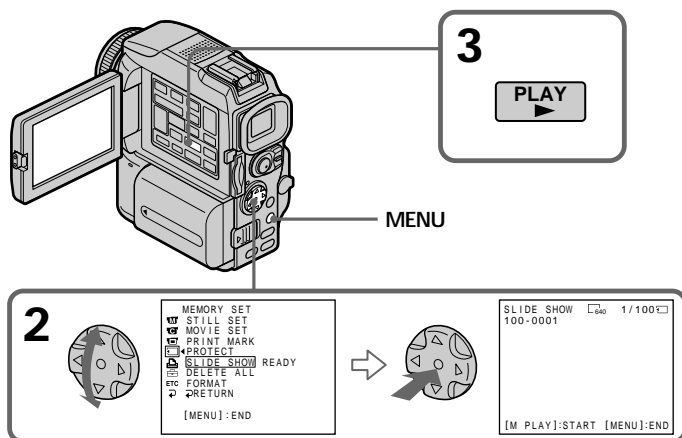

To stop the slide show

Press MENU.

To pause during a slide show

Press MEMORY PLAY.

To start the slide show from a particular image

Select the desired image using MEMORY +/- buttons before step 2.

To view the recorded images on TV

Connect your camcorder to a TV with the A/V connecting cable supplied with your camcorder before operation.

If you change the “Memory Stick” during operation



The slide show does not operate. If you change the “Memory Stick,” be sure to follow the steps again from the beginning.

Preventing accidental erasure – Image protection

To prevent accidental erasure of important images, you can protect selected images.

Before operation

Insert a “Memory Stick” into your camcorder.

- (1) Set the POWER switch to MEMORY or VCR. Make sure that the LOCK switch is set to the right (unlock) position.
- (2) Play back the image you want to protect.
- (3) Press MENU, then select and decide upon PROTECT in  with the control button (p. 96).
- (4) Select and decide upon ON with the control button.
- (5) Press MENU to make the menu display disappear. The “” mark is displayed beside the data file name of the selected image.

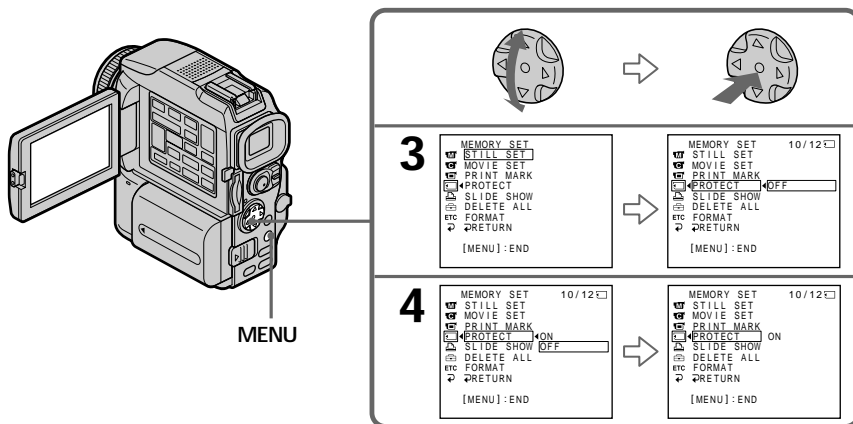

To cancel image protection

Select and decide upon OFF with the control button in step 4.

Note

Formatting erases all information on the “Memory Stick,” including the protected image data. Check the contents of the “Memory Stick” before formatting.

If the write-protect tab on the “Memory Stick” is set to LOCK
You cannot carry out image protection.

Deleting images

You can delete images stored in a “Memory Stick.” You can delete all images or selected images.

Deleting selected images

Before operation

Insert a “Memory Stick” into your camcorder.

- (1) Set the POWER switch to MEMORY or VCR. Make sure that the LOCK switch is set to the right (unlock) position.
- (2) Playback the image to delete.
- (3) Press MEMORY DELETE. “DELETE?” appears on the screen.
- (4) Press MEMORY DELETE again. The selected image is deleted.

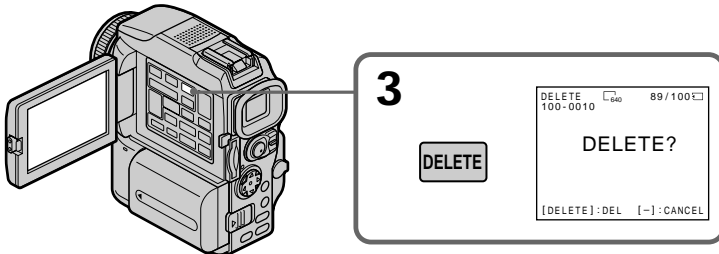

To cancel deleting an image

Press MEMORY - in step 4.

To delete an image displayed on the index screen

Press MEMORY +/- to move the ► indicator to the desired image you want to delete and follow steps 3 and 4.

Notes

- To delete a protected image, first cancel image protection.
- Once you delete an image, you cannot restore it. Check the images to delete carefully before deleting them.

If the write-protect tab on the “Memory Stick” is set to LOCK

You cannot delete images.

Deleting images

Deleting all the images

You can delete all the unprotected images in a “Memory Stick.”

Before operation

Insert a “Memory Stick” into your camcorder.

- (1) Set the POWER switch to MEMORY. Make sure that the LOCK switch is set to the right (unlock) position.
- (2) Press MENU, then select and decide upon DELETE ALL in  with the control button (p. 96).
- (3) Select and decide upon OK with the control button. OK changes to EXECUTE.
- (4) Select and decide upon EXECUTE with the control button. DELETING flashes on the screen. When all the unprotected images are deleted, COMPLETE is displayed.

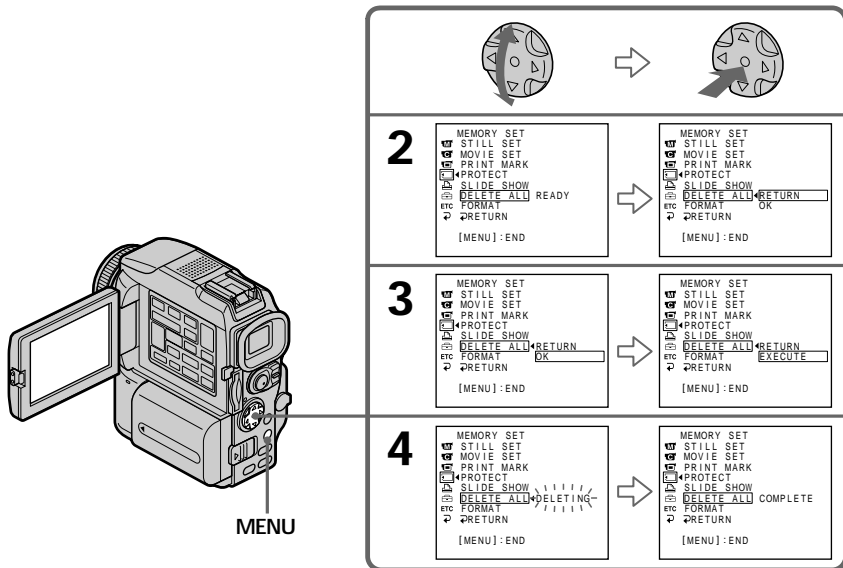

To cancel deleting all the images in the “Memory Stick”

Select and decide upon RETURN with the control button in step 3.

While DELETING appears

Do not turn the POWER switch or press any buttons.



Writing a print mark – PRINT MARK

You can specify the recorded still image to print out by putting marks. This function is useful for printing out still images later.

Your camcorder conforms with the DPOF (Digital Print Order Format) standard for specifying the still images to print out.

Before operation

Insert a “Memory Stick” into your camcorder.

- (1) Set the POWER switch to MEMORY or VCR. Make sure that the LOCK switch is set to the right (unlock) position.
- (2) Playback the still image you want to write a print mark on.
- (3) Press MENU, then select and decide upon PRINT MARK in  with the control button (p. 96).
- (4) Select and decide upon ON with the control button.
- (5) Press MENU to make the menu display disappear. The print mark  is displayed beside the data file name of the image.

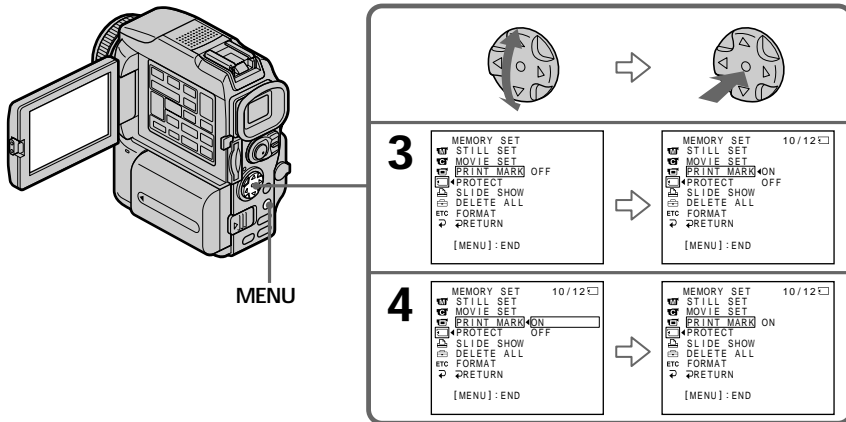

“Memory Stick” Operations

To cancel writing print marks

Select and decide upon OFF with the control button in step 4.

If the write-protect tab on the “Memory Stick” is set to LOCK

You cannot write print marks on still images.

Moving pictures

You cannot write print marks on moving pictures.

While the file name is flashing

You cannot write a print mark on the still image.

Using the optional printer

You can use the optional printer on your camcorder to print images on the print paper. For details, refer to the operating instructions of the printer. There are various ways of printing still images. The following, however, describes how to print by selecting  in the menu on your camcorder.

Before operation

- Insert a recorded “Memory Stick” into your camcorder.
- Connect the optional printer to your camcorder as illustrated.

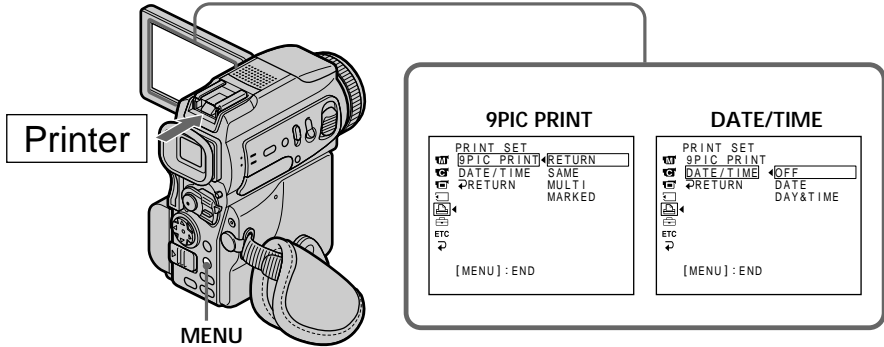

You can print nine still images on the 9-split print paper. Select the desired mode in the menu settings.

SAME PICS



MULTI PICS or *MARKED PICS



* Nine still images with print marks are printed together.

You can make prints with the recording date and/or recording time. Select the desired mode in the menu settings.

DATE

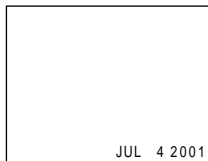

DAY & TIME

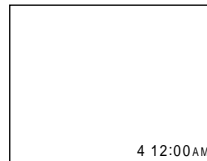

Images recorded in multi screen mode

You cannot print images recorded in multi screen mode on sticker type print paper.

Moving pictures recorded on “Memory Stick”

You cannot print moving pictures.

When “Memory Stick” has no files

“ NO STILL IMAGE FILE” appears on the screen.

When there are no files with a PRINT MARK

“ NO PRINT MARK” appears on the screen.

Accessing the network

– DCR-PC120BT only

You can access the Internet using a Bluetooth equipped device that is complied to the camcorder. Once the access is made, you can view a Web page, send/receive your e-mail, etc. This section described only how to open the Network Menu.

- (1) Set the POWER switch to MEMORY.
 - (2) Press NETWORK.
-  (Bluetooth) lamp flashes and Network Menu appears.

For the details, refer to the Network Function Operating Instructions supplied with your camcorder.

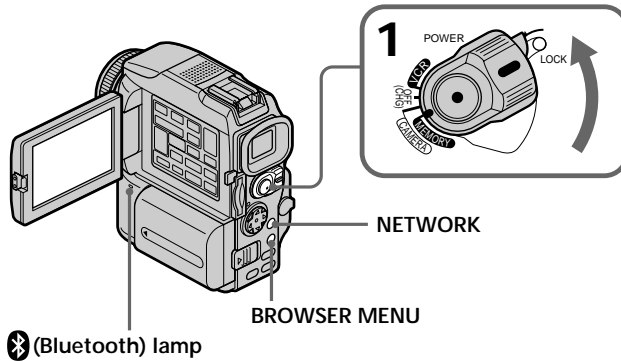

On trademarks

- The BLUETOOTH trademarks are owned by their proprietor and used by Sony Corporation under license.
- All other product names mentioned herein may be the trademarks or registered trademarks of their respective companies. Furthermore, “™” and “®” are not mentioned in each case in this manual.

Note

Make sure that your camcorder is in the standby mode with the POWER switch set to MEMORY.

During using the network function

You cannot use the optional printer.

Types of trouble and their solutions

If you run into any problem using your camcorder, use the following table to troubleshoot the problem. If the problem persists, disconnect the power source and contact your Sony dealer or local authorized Sony service facility. If “C:□□:□□” appears on the screen, the self-diagnosis display function has worked. See page 162.

In the recording mode

Symptom	Cause and/or Corrective Actions
START/STOP does not operate.	<ul style="list-style-type: none"> • The POWER switch is not set to CAMERA. → Set it to CAMERA (p. 20). • The tape has run out. → Rewind the tape or insert a new one (p. 19, 33). • The write-protect tab is set to expose the red mark. → Use a new tape or slide the tab (p. 19). • The tape is stuck to the drum (moisture condensation). → Remove the cassette and leave your camcorder for at least one hour to acclimatize (p. 172).
The power goes off.	<ul style="list-style-type: none"> • While being operated in CAMERA mode, your camcorder has been in the standby mode for more than five minutes. → Set the POWER switch to OFF (CHG) and then to CAMERA. • The battery pack is dead or nearly dead. → Install a charged battery pack.
The image on the viewfinder screen is not clear.	<ul style="list-style-type: none"> • Viewfinder is not extended to the end. → Pull out the viewfinder (p. 23). • The viewfinder lens is not adjusted. → Adjust the viewfinder lens (p. 23).
The SteadyShot function does not work.	<ul style="list-style-type: none"> • STEADYSHOT is set to OFF in the menu settings. → Set it to ON (p. 96).
The autofocus function does not work.	<ul style="list-style-type: none"> • The setting is the manual focus mode. → Set FOCUS to the auto focus mode (p. 53). • Shooting conditions are not suitable for autofocus. → Adjust to focus manually (p. 53).
The picture does not appear in the viewfinder.	<ul style="list-style-type: none"> • The LCD panel is open. → Close the LCD panel (p. 22).
A vertical band appears when you shoot a subject such as lights or a candle flame against a dark background.	<ul style="list-style-type: none"> • The contrast between the subject and background is too high. Your camcorder is not a malfunction.
A vertical band appears when you shoot a very bright subject.	<ul style="list-style-type: none"> • Your camcorder is not a malfunction.
Some tiny white spots appear on the screen.	<ul style="list-style-type: none"> • Slow shutter, low lux of PROGRAM AE or Super NightShot mode is activated. This is not a malfunction.
An unknown picture is displayed on the screen.	<ul style="list-style-type: none"> • If 10 minutes elapse after you set the POWER switch to CAMERA or DEMO MODE is set to ON in the menu settings without a cassette inserted, your camcorder automatically starts the demonstration. → Insert a cassette and the demonstration stops. You can also cancel DEMO MODE (p. 102).

Types of trouble and their solutions





Symptom	Cause and/or Corrective Actions
The picture is recorded in incorrect or unnatural colors.	<ul style="list-style-type: none"> • NIGHTSHOT is set to ON. → Set it to OFF (p. 27).
The picture appears too bright, and the subject does not appear on the screen.	<ul style="list-style-type: none"> • NIGHTSHOT is set to ON in a bright place. → Set it to OFF (p. 27). • The backlight function is active. → Set it off (p. 27).
The click of the shutter does not sound.	<ul style="list-style-type: none"> • BEEP is set to OFF in the menu settings. → Set it to MELODY or NORMAL (p. 96).
Black bands appear when you record TV or computer screen.	<ul style="list-style-type: none"> • Set the STEADYSHOT in the menu settings to OFF (p. 96).
An external flash (optional) does not work.	<ul style="list-style-type: none"> • The power of the external flash is off or the power source is not installed. → Turn on the external flash or install the power source. • Two or more external flashes (optional) are attached. → Only one external flash (optional) can be attached.

In the playback mode

Symptom	Cause and/or Corrective Actions
The tape does not move when a video control button is pressed.	<ul style="list-style-type: none"> • The POWER switch is not set to VCR. → Set it to VCR (p. 31).
The playback button does not work.	<ul style="list-style-type: none"> • The tape has run out. → Rewind the tape (p. 31).
There are horizontal lines on the picture or the playback picture is not clear or does not appear.	<ul style="list-style-type: none"> • The video head may be dirty. → Clean the heads using the cleaning cassette (optional) (p. 173).
No sound or only a low sound is heard when playing back a tape.	<ul style="list-style-type: none"> • The stereo tape is played back with HiFi SOUND set to 2 in the menu settings. → Set it to STEREO (p. 96). • The volume is turned to minimum. → Turn up the volume (p. 31). • AUDIO MIX is set to ST2 in the menu settings. → Adjust AUDIO MIX (p. 96).
Displaying the recorded date, date search function does not work.	<ul style="list-style-type: none"> • The tape has no cassette memory. → Use a tape with cassette memory (p. 63). • CM SEARCH is set to OFF in the menu settings. → Set it to ON (p. 96). • The tape has a blank portion in the recorded portion (p. 64).
The title search function does not work.	<ul style="list-style-type: none"> • The tape has no cassette memory. → Use a tape with cassette memory (p. 62). • CM SEARCH is set to OFF in the menu settings. → Set it to ON (p. 96). • There is no title in the tape. → Superimpose the titles (p. 90). • The tape has a blank portion in the recorded portion (p. 62).
The new sound added to the recorded tape is not heard.	<ul style="list-style-type: none"> • AUDIO MIX is set to ST1 side in the menu settings. → Adjust AUDIO MIX (p. 96).
The title is not displayed.	<ul style="list-style-type: none"> • TITLE DSPL is set to OFF in the menu settings. → Set it to ON (p. 96).

Types of trouble and their solutions

In the recording and playback modes

Symptom	Cause and/or Corrective Actions
The power does not turn on.	<ul style="list-style-type: none"> The battery pack is not installed, or is dead or nearly dead. → Install a charged battery pack (p. 12, 13). The AC power adaptor is not connected to a wall outlet. → Connect the AC power adaptor to a wall outlet (p. 15).
The end search function does not work.	<ul style="list-style-type: none"> The tape was ejected after recording when using a tape without cassette memory (p. 30). You have not recorded on the new cassette yet (p. 30).
The end search function does not work correctly.	<ul style="list-style-type: none"> The tape has a blank portion in the beginning or middle (p. 30).
The battery pack is quickly discharged.	<ul style="list-style-type: none"> The operating temperature is too low. The battery pack is not fully charged. → Charge the battery pack fully again (p. 13). The battery pack is completely dead, and cannot be recharged. → Replace with a new battery pack (p. 12).
The battery remaining indicator does not indicate the correct time.	<ul style="list-style-type: none"> You have used the battery pack in an extremely hot or cold environment for a long time. The battery pack is completely dead, and cannot be recharged. → Replace with a new battery pack (p. 12). The battery is not fully charged. → Install a charged battery pack (p. 12, 13). A deviation has occurred in the remaining battery time. → Charge the battery pack fully again so that the indication on the battery remaining indicator is correct (p. 13).
The power goes off although the battery remaining indicator indicates that the battery pack has enough power to operate.	<ul style="list-style-type: none"> A deviation has occurred in the remaining battery time. → Charge the battery pack fully again so that the indication on the battery remaining indicator is correct (p. 13).
The cassette cannot be removed from the holder.	<ul style="list-style-type: none"> The power source is disconnected. → Connect it firmly (p. 12, 15). The battery is dead. → Use a charged battery pack (p. 12, 13).
The  and  indicators flash and no functions except for cassette ejection work.	<ul style="list-style-type: none"> Moisture condensation has occurred. → Remove the cassette and leave your camcorder for at least one hour to acclimatize (p. 172).
 indicator does not appear when using a tape with cassette memory.	<ul style="list-style-type: none"> The gold-plated connector of the tape is dirty or dusty. → Clean the gold-plated connector (p. 166).
Remaining tape indicator is not displayed.	<ul style="list-style-type: none"> The  REMAIN is set to AUTO in the menu settings. → Set it to ON to always display the remaining tape indicator (p. 96).

Types of trouble and their solutions

When operating using the “Memory Stick”

Symptom	Cause and/or Corrective Actions
The “Memory Stick” does not function.	<ul style="list-style-type: none">• The POWER switch is not set to MEMORY. → Set it to MEMORY (p. 112).• The “Memory Stick” is not inserted. → Insert a “Memory Stick” (p. 106).
Recording does not function.	<ul style="list-style-type: none">• The “Memory Stick” has already been recorded to its full capacity. → Delete unnecessary images and record again (p. 151).• The “Memory Stick” formatted incorrectly is inserted. → Format the “Memory Stick” or use another “Memory Stick” (p. 100, 106).• The write-protect tab on the “Memory Stick” is set to LOCK. → Release the lock (p. 104).
The image cannot be deleted.	<ul style="list-style-type: none">• The image is protected. → Cancel image protection (p. 150).• The write-protect tab on the “Memory Stick” is set to LOCK. → Release the lock (p. 104).
You cannot format the “Memory Stick”.	<ul style="list-style-type: none">• The write-protect tab on the “Memory Stick” is set to LOCK. → Release the lock (p. 104).
Deleting all the images cannot be carried out.	<ul style="list-style-type: none">• The write-protect tab on the “Memory Stick” is set to LOCK. → Release the lock (p. 104).
You cannot protect the image.	<ul style="list-style-type: none">• The write-protect tab on the “Memory Stick” is set to LOCK. → Release the lock (p. 104).• The image to protect is not be played back. → Press MEMORY PLAY to play back the image (p. 136).
You cannot write a print mark on the still image.	<ul style="list-style-type: none">• The write-protect tab on the “Memory Stick” is set to LOCK. → Release the lock (p. 104).• The image to write a print mark is not be played back. → Press MEMORY PLAY to play back the image (p. 136).• You are trying to write a print mark on a moving picture. → Print marks cannot be written on a moving picture.
The photo save function does not work.	<ul style="list-style-type: none">• The write-protect tab on the “Memory Stick” is set to LOCK. → Release the lock (p. 104).
You cannot playback images in actual size.	<ul style="list-style-type: none">• You may not be able to playback images in actual size when you try to play back images recorded by other equipment. This is not a malfunction.

(continued on the following page)

Types of trouble and their solutions

Others

Symptom	Cause and/or Corrective Actions
The title is not recorded.	<ul style="list-style-type: none">• The tape has no cassette memory. → Use a tape with cassette memory (p. 90).• The cassette memory is full. → Erase unnecessary titles (p. 92).• The tape is set to prevent accidental erasure. → Slide the write-protect tab so that red portion is not visible (p. 19).• The tape has a blank portion in the recorded portion. → Superimpose the title to the recorded position (p. 91).
The cassette label is not recorded.	<ul style="list-style-type: none">• The tape has no cassette memory. → Use a tape with cassette memory (p. 94).• The cassette memory is full. → Erase unnecessary data (p. 92).• The tape is set to prevent accidental erasure. → Slide the write-protect tab so that red portion is not visible (p. 19).
Digital program editing to a tape does not function.	<ul style="list-style-type: none">• The input selector on the VCR is not set correctly. → Check the connection and set the input selector on the VCR again (p. 69)• The camcorder is connected to DV equipment of other than Sony using the i.LINK cable (DV connecting cable). → Set it to IR (p. 70).• Setting program on a blank portion of the tape is attempted. → Set the program again on a recorded portion (p. 78).• The camcorder and the VCR are not synchronized. → Adjust the synchronization (p. 75).• The IR SETUP code is incorrect. → Set the correct code (p. 71).
Digital program editing to a "Memory Stick" does not function.	<ul style="list-style-type: none">• Setting program on a blank portion of the tape is attempted. → Set the program again on a recorded portion (p. 133).
The Remote Commander supplied with your camcorder does not work.	<ul style="list-style-type: none">• COMMANDER is set to OFF in the menu settings. → Set it to ON (p. 96).• Something is blocking the infrared rays. → Remove the obstacle.• The batteries are inserted in the battery holder with the + - polarities incorrectly matching the + - marks. → Insert the batteries with the correct polarity (p. 185).• The batteries are dead. → Insert new ones (p. 185).
The picture from a TV or VCR does not appear even when your camcorder is connected to output on the TV or VCR.	<ul style="list-style-type: none">• DISPLAY is set to V-OUT/LCD in the menu settings. → Set it to LCD (p. 96).

Types of trouble and their solutions

Symptom	Cause and/or Corrective Actions
The melody or beep sounds for five seconds.	<ul style="list-style-type: none"> Moisture condensation has occurred. <ul style="list-style-type: none"> → Remove the cassette and leave your camcorder for at least one hour to acclimatize (p. 172). Some troubles have occurred in your camcorder. <ul style="list-style-type: none"> → Remove the cassette and insert it again, then operate your camcorder.
No function works though the power is on.	<ul style="list-style-type: none"> Disconnect the power cord of the AC power adaptor or remove the battery, then reconnect it in about one minute. Turn the power on. If the functions still do not work, press the RESET button using a sharp-pointed object (If you press the RESET button, all the settings including the date and time return to the default.) (p. 182).
When you set the POWER switch to VCR or OFF (CHG), if you move your camcorder, you may hear a clatter sound from inside your camcorder.	<ul style="list-style-type: none"> This is because some functions use a linear mechanism. Your camcorder is not a malfunction.
While charging the battery pack, the CHG lamp does not light up.	<ul style="list-style-type: none"> Charge is completed. The battery pack is not properly installed. <ul style="list-style-type: none"> → Install it properly (p. 12).
You cannot charge the battery pack.	<ul style="list-style-type: none"> The POWER switch is not set to OFF (CHG). <ul style="list-style-type: none"> → Set it to OFF (CHG) (p. 13).
While charging the battery pack, the CHG lamp flashes.	<ul style="list-style-type: none"> The battery pack is not properly installed. <ul style="list-style-type: none"> → Install it properly (p. 12). Something is wrong with the battery pack. <ul style="list-style-type: none"> → Please contact your Sony dealer or local authorized Sony service facility.
Image data cannot be transferred by the USB connection.	<ul style="list-style-type: none"> The USB cable was connected before installation of the USB driver was completed. <ul style="list-style-type: none"> → Uninstall the incorrect USB driver and re-install the USB driver (p. 143).
The cassette cannot be removed even if the cassette lid is open.	<ul style="list-style-type: none"> Moisture has started to condense in your camcorder (p. 172).

Self-diagnosis display

Your camcorder has a self-diagnosis display function.

This function displays the current condition of your camcorder as a 5-digit code (a combination of a letter and figures) on the screen. If a 5-digit code is displayed, check the following code chart. The last two digits (indicated by □□) will differ depending on the state of your camcorder.

LCD screen or Viewfinder

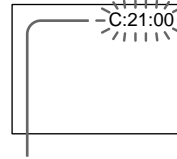

Self-diagnosis display

- C:□□:□□
You can service your camcorder yourself.
- E:□□:□□
Contact your Sony dealer or local authorized Sony service facility.

Five-digit display	Cause and/or Corrective Actions
C:04:□□	<ul style="list-style-type: none"> • You are using a battery pack that is not an "InfoLITHIUM" battery pack. → Use an "InfoLITHIUM" battery pack (p. 15, 167).
C:21:□□	<ul style="list-style-type: none"> • Moisture condensation has occurred. → Remove the cassette and leave your camcorder for at least one hour to acclimatize (p. 172).
C:22:□□	<ul style="list-style-type: none"> • The video heads are dirty. → Clean the heads using the cleaning cassette (optional) (p. 173).
C:31:□□ C:32:□□	<ul style="list-style-type: none"> • A malfunction other than the above that you can service has occurred. → Remove the cassette and insert it again, then operate your camcorder. → Disconnect the power cord of the AC power adaptor or remove the battery pack. After reconnecting the power source, operate your camcorder.
E:61:□□ E:62:□□ E:91:□□	<ul style="list-style-type: none"> • A malfunction that you cannot service has occurred. → Contact your Sony dealer or local authorized Sony service facility and inform them of the 5-digit code (example: E:61:10).

If you are unable to rectify the problem even if you try corrective actions a few times, contact your Sony dealer or local authorized Sony service facility.

Warning indicators and messages

If indicators and messages appear on the screen, check the following:
See the page in parentheses “()” for more information.

Warning indicators

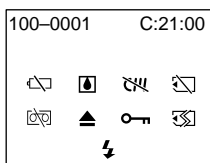

100-0001 Warning indicator as to file

Slow flashing:

- The file is corrupted.
- The file is unreadable.
- You are trying to carry out MEMORY MIX function on moving picture (p. 121).

C:21:00 Self-diagnosis display (p. 162).

The battery is dead or nearly dead

Slow flashing:

- The battery is nearly dead.
- Depending on the operating conditions, environment and battery condition, the  indicator may flash, even if there are approximately five to 10 minutes remaining.

Fast flashing:

- The battery is dead (p. 13).

Moisture condensation has occurred*

Fast flashing:

- Eject the cassette, turn off your camcorder, and leave it for about one hour with the cassette compartment open (p. 172).

Warning indicator as to cassette memory*

Slow flashing:

- No tape with cassette memory is inserted (p. 165).

Warning indicator as to “Memory Stick”*

Slow flashing:

- No “Memory Stick” is inserted.

Fast flashing:

- The “Memory Stick” is not readable with your camcorder (p. 104).
- The image cannot be recorded on “Memory Stick” (p. 118).

Warning indicator as to “Memory Stick” formatting*

Fast flashing:

- “Memory Stick” is not formatted correctly (p. 100).
- The “Memory Stick” data is corrupted (p. 104).

Warning indicator as to tape

Slow flashing:

- The tape is near the end.
- No tape is inserted.*
- The write-protect tab on the cassette is out (red) (p. 19).*

Fast flashing:

- The tape has run out.*

You need to eject the cassette*

Slow flashing:

- The write-protect tab on the cassette is out (red) (p. 19).

Fast flashing:

- Moisture condensation has occurred (p. 172).
- The tape has run out.
- The self-diagnosis display function is activated (p. 162).

The image is protected*

Slow flashing:

- The image is protected (p. 150).

Warning indicator as to the flash

Slow flashing:

- During charging























Fast flashing:

- The self-diagnosis display function is activated (p. 162).*
- There is something wrong with the built-in flash or the external flash (optional).



* You hear the melody or beep sound.

Warning indicators and messages

Warning messages

- CLOCK SET Set the date and time (p. 16).
- FOR “InfoLITHIUM” BATTERY ONLY Use an “InfoLITHIUM” battery pack (p. 15).
-  CLEANING CASSETTE** The video heads are dirty (p. 173).
-  FULL The tape cassette memory is full.*
-  16BIT AUDIO MODE is set to 16BIT (p. 102).* You cannot dub new sound.
-  REC MODE REC MODE is set to LP (p. 102).* You cannot dub new sound.
-  TAPE There is no recorded portion on the tape.* You cannot dub new sound.
-  “i.LINK” CABLE i.LINK cable is connected (p. 89).* You cannot dub new sound.
-  FULL The “Memory Stick” is full (p. 114).*
-   The write-protect tab on the “Memory Stick” is set to LOCK (p. 104).*
-  NO FILE No still image is recorded on the “Memory Stick” (p. 136).*
-  NO MEMORY STICK No “Memory Stick” is inserted.*
-  AUDIO ERROR You are trying to record an image with sound that cannot be recorded by your camcorder on “Memory Stick” (p. 129).*
-  MEMORY STICK ERROR The “Memory Stick” data is corrupted (p. 106).*
-  FORMAT ERROR The “Memory Stick” is not recognized. Check the format (p. 100).*
-   DIRECTORY ERROR There are more than two same directories (p. 136).*
- COPY INHIBIT The tape contains copyright control signals for copyright protection of software (p. 165).*
-   TAPE END The tape has reached the end of the tape.*
-  NO TAPE Insert a cassette tape.*
-  NO PRINT MARK You selected MARKED in 9PIC PRINT in the menu settings using a “Memory Stick” contains no image with a print mark. (p. 154)*
-  NO STILL IMAGE FILE You selected MULTI in 9PIC PRINT in the menu settings using a “Memory Stick” contains no still image. (p. 154)*
- DELETING You have pressed PHOTO during deleting all images on “Memory Stick.”*
- FORMATTING You have pressed PHOTO during formatting a “Memory Stick.”*
-  NOW CHARGING Charging an external flash (optional) does not work correctly.*

* You hear the melody or beep sound.

**The  indicator and “ CLEANING CASSETTE” message appear one after another on the screen.

Usable cassettes

Selecting cassette types

You can use the ^{Mini}**DV** mini DV cassette only*. You cannot use any other **8** 8 mm, **Hi8** Hi8, **D** Digital8, **VHS** VHS, **VHS-C** VHSC, **S-VHS** S-VHS, **S-VHS-C** S-VHSC, **B** Betamax, **ED Beta** ED Betamax or **DV** DV cassette.

* There are two types of mini DV cassettes: with cassette memory and without cassette memory. Tapes with cassette memory have **CM** (Cassette Memory) mark. We recommend that you use the tape with cassette memory.

The IC memory is mounted on this type of cassette. Your camcorder can read and write data such as dates of recording or titles, etc. to this memory.

The functions using the cassette memory require successive signals recorded on the tape. If the tape has a blank portion in the beginning or between the recorded portions, a title may not be displayed properly or the search functions may not work properly. Not to make any blank portion on the tape, operate the followings.

Press END SEARCH to go to the end of the recorded portion before you begin the next recording if you operate the followings:

- you have ejected the cassette while recording.
- you have played back the tape in the VCR.
- you have used the edit search function.

If there is a blank portion or discontinuous signal on your tape, re-record from the beginning to the end of the tape concerning above.

The same result may occur when you record using a digital video camera recorder without a cassette memory function on a tape recorded by one with the cassette memory function.

CM 4K mark on the cassette

The memory capacity of tapes marked with **CM** 4K is 4KB. Your camcorder can accommodate tapes having a memory capacity of up to 16KB. 16KB tape is marked with **CM** 16K.

^{Mini}**DV** Digital Video Cassette This is the mini DV mark.

CM Cassette Memory This is the Cassette Memory mark.

These are trademarks.

Copyright signal

When you play back

Using any other video camera recorder, you cannot record on tape that has recorded a copyright control signals for copyright protection of software which is played back on your camcorder.

When you record

You cannot record software on your camcorder that contains copyright control signals for copyright protection of software.

“COPY INHIBIT” appears on the screen, in the viewfinder or on the TV screen if you try to record such software.

Your camcorder does not record copyright control signals on the tape when it records.

Usable cassettes

Audio mode

12-bit mode: The original sound can be recorded in stereo 1, and the new sound in stereo 2 in 32 kHz. The balance between stereo 1 and stereo 2 can be adjusted by selecting AUDIO MIX in the menu settings during playback. Both sounds can be played back.

16-bit mode: A new sound cannot be recorded but the original sound can be recorded in high quality. Moreover, it can also play back sound recorded in 32 kHz, 44.1 kHz or 48 kHz. When playing back a tape recorded in the 16-bit mode, 16BIT indicator appears on the screen.

When you play back a dual sound track tape

When you play back a dual sound track tape recorded in a stereo system, set HiFi SOUND to the desired mode in the menu settings (p. 96).

Sound from speaker

HiFi SOUND mode	Playing back a stereo tape	Playing back a dual sound track tape
STEREO	Stereo	Main sound and sub sound
1	Left sound	Main sound
2	Right sound	Sub sound

You cannot record dual sound programs on your camcorder.

Notes on the cassette

When affixing a label on the cassette

Be sure to affix a label only on the locations as illustrated below [a] so as not to cause malfunction of your camcorder.

After using the cassette

Rewind the tape to the beginning, put the cassette in its case, and store it in an upright position.

When the cassette memory function does not work

Reinsert a cassette. The gold-plated connector of cassettes may be dirty or dusty.

Cleaning gold-plated connector

If the gold-plated connector on the cassette is dirty or dusty, the remaining tape indicator is sometimes not displayed correctly, and you may not be able to operate functions using cassette memory. Clean up the gold-plated connector with cotton-wool swab, about every 10 times ejection of a cassette. [b]

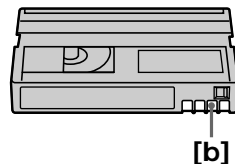
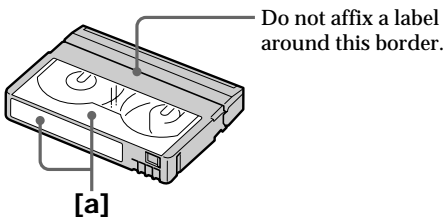

About the “InfoLITHIUM” battery pack

What is the “InfoLITHIUM” battery pack?

The “InfoLITHIUM” battery pack is a lithium-ion battery pack that has functions for communicating information related to operating conditions between the battery pack and an optional AC adaptor/charger.

The “InfoLITHIUM” battery pack calculates the power consumption according to the operating conditions of your camcorder, and displays the remaining battery time in minutes.

Charging the battery pack

- Be sure to charge the battery pack before you start using your camcorder.
- We recommend charging the battery pack in an ambient temperature of between 10°C to 30°C (50°F to 86°F) until the CHG lamp goes off, indicating that the battery pack is fully charged. If you charge the battery outside of this temperature range, you may not be able to efficiently charge the battery pack.
- After charging is completed, either disconnect the cable from the DC IN jack on your camcorder or remove the battery pack.

Effective use of the battery pack

- Battery pack performance decreases in low-temperature surroundings. So, the time that the battery pack can be used becomes shorter. We recommend the following to use the battery pack longer:
 - Put the battery pack in a pocket to warm it up, and insert it in your camcorder immediately before you start taking shots.
 - Use the large capacity battery pack (NP-FM70/FM90/FM91, optional).
- Frequently using the LCD panel or frequently operating playback, fast forward or rewind wears out the battery pack faster. We recommend using the large capacity battery pack (NP-FM70/FM90/FM91, optional).
- Be certain to turn off the power switch when not taking shots or playing back on your camcorder. The battery pack is also consumed when your camcorder is in the standby mode or playback is paused.
- Have spare battery packs handy for two or three times the expected recording time, and make trial recordings before taking the actual recording.
- Do not expose the battery pack to water. The battery pack is not water resistant.

Remaining battery time indicator

- If the power may go off although the remaining battery time indicator indicates that the battery pack has enough power to operate, charge the battery pack fully again so that the indication on the remaining battery time indicator is correct. Note, however, that the correct battery indication sometimes will not be restored if it is used in high temperatures for a long time or left in a fully charged state, or the battery pack is frequently used. Regard the remaining battery time indication as the approximate recording time.
- The  mark indicating there is little remaining battery time sometimes flashes depending on the operating conditions or ambient temperature and environment even if the remaining battery time is about five to ten minutes.

About the “InfoLITHIUM” battery pack

How to store the battery pack

- If the battery pack is not used for a long time, do the following procedure once per year to maintain proper function.
 1. Fully charge the battery.
 2. Discharge on your electronic equipment.
 3. Remove the battery from the equipment and store it in a dry, cool place.
- To use the battery pack up on your camcorder, leave your camcorder in the recording mode until the power goes off without a cassette inserted.

Battery life

- The battery life is limited. Battery capacity drops little by little as you use it more and more, and as time passes. When the available battery time is shortened considerably, a probable cause is that the battery pack has reached the end of its life. Please buy a new battery pack.
- The battery life varies according to how it is stored and operating conditions and environment for each battery pack.

About i.LINK

The DV jack on this unit is an i.LINK-compliant DV input/output jack. This section describes the i.LINK standard and its features.

What is i.LINK?

i.LINK is a digital serial interface for handling digital video, digital audio and other data in two directions between equipment having the i.LINK jack, and for controlling other equipment.

i.LINK-compatible equipment can be connected by a single i.LINK cable. Possible applications are operations and data transactions with various digital AV equipment. When two or more i.LINK-compatible equipment are connected to this unit in a daisy chain, operations and data transactions are possible with not only the equipment that this unit is connected to but also with other devices via the directly connected equipment.

Note, however, that the method of operation sometimes varies according to the characteristics and specifications of the equipment to be connected, and that operations and data transactions are sometimes not possible on some connected equipment.

Note

Normally, only one piece of equipment can be connected to this unit by the i.LINK cable (DV cable). When connecting this unit to i.LINK-compatible equipment having two or more i.LINK jacks (DV jacks), refer to the instruction manual of the equipment to be connected.

About the Name "i.LINK"

i.LINK is a more familiar term for IEEE 1394 data transport bus proposed by SONY, and is a trademark approved by many corporations.

IEEE 1394 is an international standard standardized by the Institute of Electrical and Electronic Engineers.

i.LINK Baud rate

i.LINK's maximum baud rate varies according to the equipment. Three maximum baud rates are defined:

S100 (approx. 100Mbps*)

S200 (approx. 200Mbps)

S400 (approx. 400Mbps)

The baud rate is listed under "Specifications" in the instruction manual of each equipment. It is also indicated near the i.LINK jack on some equipment.

The maximum baud rate of equipment on which it is not indicated such as this unit is "S100".

When units are connected to equipment having a different maximum baud rate, the baud rate sometimes differs from the indicated baud rate.

*What is Mbps?

Mbps stands for megabits per second, or the amount of data that can be sent or received in one second. For example, a baud rate of 100Mbps means that 100 megabits of data can be sent in one second.

About i.LINK

i.LINK functions on this unit

For details on how to dub when this unit is connected to other video equipment having DV jacks, see page 68 and 82.

This unit can also be connected to other i.LINK (DV) compatible equipment made by SONY (e.g. VAIO series personal computer) other than video equipment.

Before connecting this unit to a personal computer, make sure that application software supported by this unit is already installed on the personal computer.

For details on precautions when connecting this unit, also refer to the instruction manuals for the equipment to be connected.

Required i.LINK Cable

Use the Sony i.LINK 4-pin-to-4-pin cable (during DV dubbing).

i.LINK and  are trademarks.

Using your camcorder abroad

Using your camcorder abroad

Countries and areas where you can use network functions are restricted. For details, refer to the separate Network Operating Instructions. (DCR-PC120BT only)

You can use your camcorder in any country or area with the AC power adaptor supplied with your camcorder within 100 V to 240 V AC, 50/60 Hz.

When charging the battery pack, use a commercially available AC plug adaptor [a], if necessary, depending on the design of the wall outlet [b].

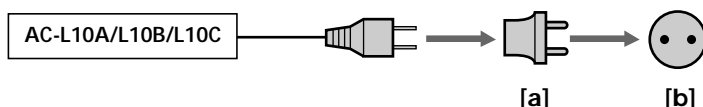

Your camcorder is an NTSC system based camcorder. If you want to view the playback picture on a TV, it must be an NTSC system based TV with the AUDIO/VIDEO input jack.

The following shows TV color systems used overseas.

NTSC system

Bahama Islands, Bolivia, Canada, Central America, Chile, Colombia, Ecuador, Jamaica, Japan, Korea, Mexico, Peru, Surinam, Taiwan, the Philippines, the U.S.A., Venezuela, etc.

PAL system

Australia, Austria, Belgium, China, Czech Republic, Denmark, Finland, Germany, Great Britain, Holland, Hong Kong, Italy, Kuwait, Malaysia, New Zealand, Norway, Portugal, Singapore, Slovak Republic, Spain, Sweden, Switzerland, Thailand, etc.

PAL-M system

Brazil

PAL-N system



Argentina, Paraguay, Uruguay

SECAM system

Bulgaria, France, Guyana, Hungary, Iran, Iraq, Monaco, Poland, Russia, Ukraine, etc.

Maintenance information and precautions

Moisture condensation

If your camcorder is brought directly from a cold place to a warm place, moisture may condense inside your camcorder, on the surface of the tape, or on the lens. In this condition, the tape may stick to the head drum and be damaged or your camcorder may not operate correctly. If there is moisture inside your camcorder, the beep sounds and the  indicator flashes. When the  indicator flashes at the same time, the cassette is inserted in your camcorder. If moisture condenses on the lens, the indicator will not appear.

If moisture condensation occurred

None of the functions except cassette ejection will work. Eject the cassette, turn off your camcorder, and leave it for about one hour with the cassette lid open. Your camcorder can be used again if the  indicator does not appear when the power is turned on again.

If moisture starts to condense, your camcorder sometimes cannot detect condensation. If this happens, the cassette sometimes is not ejected for 10 seconds after the cassette lid is opened. This is not a malfunction. Do not close the cassette lid until the cassette is ejected.

Note on moisture condensation

Moisture may condense when you bring your camcorder from a cold place into a warm place (or vice versa) or when you use your camcorder in a hot place as follows:

- You bring your camcorder from a ski slope into a place warmed up by a heating device.
- You bring your camcorder from an air-conditioned car or room into a hot place outside.
- You use your camcorder after a squall or a shower.
- You use your camcorder in a high temperature and humidity place.

How to prevent moisture condensation



When you bring your camcorder from a cold place into a warm place, put your camcorder in a plastic bag and tightly seal it. Remove the bag when the air temperature inside the plastic bag has reached the surrounding temperature (after about one hour).

Maintenance information and precautions

Maintenance information

Cleaning the video head

To ensure normal recording and clear pictures, clean the video heads. The video head may be dirty when:

- mosaic-pattern noise appears on the playback picture.
- playback pictures do not move.
- playback pictures do not appear.
- the  indicator and "CLEANING CASSETTE" message appear one after another or the  indicator flashes on the screen during recording.

If the above problem, [a], [b] or [c] occurs, clean the video heads for 10 seconds with the Sony DVM-12CLD cleaning cassette (optional). Check the picture and if the above problem persists, repeat cleaning.

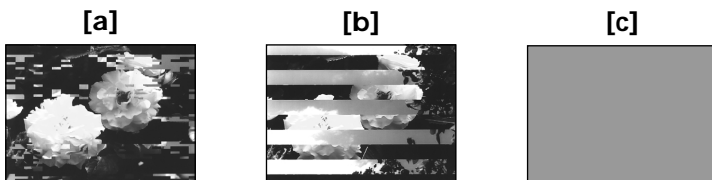



If the video heads get dirtier, the entire screen becomes blue [c].

Cleaning the LCD screen

If fingerprints or dust make the LCD screen dirty, we recommend using a LCD Cleaning Kit (optional) to clean the LCD screen.

Removing dust from inside the viewfinder

- (1) Pull out the viewfinder in the direction of the arrow .
- Remove the two screws in the direction of the arrow  with a screwdriver (optional). Remove the eyecup in the direction of the arrow .

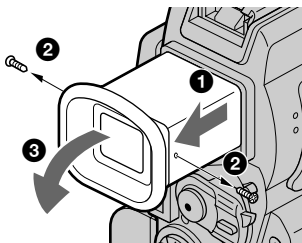

- (2) Remove dust from inside the eyecup and viewfinder with a commercially available blower.
- (3) In the reverse way of (1), attach the eyecup. Then replace the screws in the direction of the arrow .

Caution

Do not remove any other screws. You may remove only the screw to remove the eyecup.

Notes

- Do not drop or bend the eyecup shaft.
- Be careful when handling the eyecup.

Charging the built-in rechargeable battery

Your camcorder is supplied with a built-in rechargeable battery installed so as to retain the date and time, etc., regardless of the setting of the POWER switch. The built-in rechargeable battery is always charged as long as you are using your camcorder. The battery, however, will get discharged gradually if you do not use your camcorder. It will be completely discharged in about three months if you do not use your camcorder at all. Even if the built-in rechargeable battery is not charged, it will not affect the camcorder operation. To retain the date and time, etc., charge the battery if the battery is discharged.

Charging the built-in rechargeable battery:

- Connect your camcorder to house current using the AC power adaptor supplied with your camcorder, and leave your camcorder with the power switch turned off for more than 24 hours.
- Or install the fully charged battery pack in your camcorder, and leave your camcorder with the POWER switch set to OFF (CHG) for more than 24 hours.

Precautions

Camcorder operation

- Operate your camcorder on 7.2 V (battery pack) or 8.4 V (AC power adaptor).
- For DC or AC operation, use the accessories recommended in this operating instructions.
- If any solid object or liquid get inside the casing, unplug your camcorder and have it checked by a Sony dealer before operating it any further.
- Avoid rough handling or mechanical shock. Be particularly careful of the lens.
- Keep the POWER switch set to OFF (CHG) when you are not using your camcorder.
- Do not wrap your camcorder with a towel, for example, and operate it. Doing so might cause heat to build up inside.
- Keep your camcorder away from strong magnetic fields or mechanical vibration.
- Do not touch the LCD screen with your fingers or a sharp-pointed object.
- If your camcorder is used in a cold place, a residual image may appear on the LCD screen. This is not a malfunction.
- While using your camcorder, the back of the LCD screen may heat up. This is not a malfunction.

On handling tapes

- Do not insert anything into the small holes on the rear of the cassette. These holes are used to sense the type and thickness of the tape and if the recording tab is in or out.
- Do not open the tape protect cover or touch the tape.
- Avoid touching or damaging the terminals. To remove dust, clean the terminals with a soft cloth.

Maintenance information and precautions

Camcorder care

- Remove the tape, and periodically turn on the power, operate the CAMERA and VCR sections and play back a tape for about three minutes when your camcorder is not to be used for a long time.
- Clean the lens with a soft brush to remove dust. If there are fingerprints on the lens, remove them with a soft cloth.
- Clean the camcorder body with a dry soft cloth, or a soft cloth lightly moistened with a mild detergent solution. Do not use any type of solvent which may damage the finish.
- Do not let sand get into your camcorder. When you use your camcorder on a sandy beach or in a dusty place, protect it from the sand or dust. Sand or dust may cause your camcorder to malfunction, and sometimes this malfunction cannot be repaired.

AC power adaptor

- Unplug the unit from the wall outlet when you are not using the unit for a long time. To disconnect the power cord, pull it out by the plug. Never pull the power cord itself.
- Do not operate the unit with a damaged cord or if the unit has been dropped or damaged.
- Do not bend the power cord forcibly, or place a heavy object on it. This will damage the cord and may cause fire or electrical shock.
- Prevent metallic objects from coming into contact with the metal parts of the connecting section. If this happens, a short may occur and the unit may be damaged.
- Always keep metal contacts clean.
- Do not disassemble the unit.
- Do not apply mechanical shock or drop the unit.
- While the unit is in use, particularly during charging, keep it away from AM receivers and video equipment. AM receivers and video equipment disturb AM reception and video operation.
- The unit becomes warm during use. This is not a malfunction.
- Do not place the unit in locations that are:
 - Extremely hot or cold
 - Dusty or dirty
 - Very humid
 - Vibrating

About care and storage of the lens

- Wipe the surface of the lens clean with a soft cloth in the following instance:
 - When there are fingerprints on the lens surface
 - In hot or humid locations
 - When the lens is used in environments such as the seaside
- Store the lens in a well-ventilated location subject to little dirt or dust.

To prevent mold from occurring, periodically perform the above.

We recommend turning on and operating the video camera recorder about once per month to keep the video camera recorder in an optimum state for a long time.

Battery pack

- Use only the specified charger or video equipment with the charging function.
- To prevent accident from a short circuit, do not allow metal objects to come into contact with the battery terminals.
- Keep the battery pack away from fire.
- Never expose the battery pack to temperatures above 60°C (140°F), such as in a car parked in the sun or under direct sunlight.
- Keep the battery pack dry.
- Do not expose the battery pack to any mechanical shock.
- Do not disassemble nor modify the battery pack.
- Attach the battery pack to the video equipment securely.

Notes on dry batteries

To avoid possible damage from battery leakage or corrosion, observe the following:

- Be sure to insert the batteries with the + - polarities matched to the + - marks.
- Dry batteries are not rechargeable.
- Do not use a combination of new and old batteries.
- Do not use different types of batteries.
- Current flows from batteries when you are not using them for a long time.
- Do not use leaking batteries.

If batteries are leaking

- Wipe off the liquid in the battery compartment carefully before replacing the batteries.
- If you touch the liquid, wash it off with water.
- If the liquid get into your eyes, wash your eyes with a lot of water and then consult a doctor.

If any problem occurs, unplug your camcorder and contact your nearest Sony dealer.

Specifications

Video camera recorder

System

Video recording system

2 rotary heads

Helical scanning system

Audio recording system

Rotary heads, PCM system

Quantization: 12 bits (Fs 32

kHz, stereo 1, stereo 2), 16 bits

(Fs 48 kHz, stereo)

Video signal

NTSC color, EIA standards

Usable cassette

Mini DV cassette with the  mark printed

Tape speed

SP: Approx. 18.81 mm/s

LP: Approx. 12.56 mm/s

Recording/playback time

(using cassette DVM60)

SP: 1 hour

LP: 1.5 hours

Fastforward/rewind time

(using cassette DVM60)

When using the battery pack:

Approx. 2 min. and 30 seconds

When using the AC power

adaptor:

Approx. 1 min. and 45 seconds

Viewfinder

Electric viewfinder (color)

Image device

4.5 mm (1/4 type) CCD

(Charge Coupled Device)

Approx. 1 550 000 pixels

(Effective (moving): 970 000

pixels)

(Effective (still): 1 390 000

pixels)

Lens

Carl Zeiss Vario-Sonnar T*

Combined power zoom lens

Filter diameter: 37 mm

(1 1/2 in.)

10× (Optical), 120× (Digital)

Focal length

4.2 – 42 mm (3/16 – 1 11/16 in.)

When converted to a 35 mm

still camera

Camera mode:

48 – 480 mm (1 15/16 – 19 in.)

Memory mode:

40 – 400 mm (1 5/8 – 15 3/4 in.)

Color temperature

Auto, HOLD (Hold),  Indoor

(3 200 K),  Outdoor (5 800 K)

Minimum illumination

7 lx (lux) (F 1.8)

0 lx (lux) (in the NightShot

mode)*

* Objects unable to be seen due to the dark can be shot with infrared lighting.

Input/Output connectors

S video input/output

4-pin mini DIN

Luminance signal: 1 Vp-p,

75 Ω (ohms), unbalanced

Chrominance signal: 0.286 Vp-p,

75 Ω (ohms), unbalanced

Audio/Video input/output

AV MINI JACK, 1 Vp-p,

75 Ω (ohms), unbalanced, sync

negative

327 mV, (at output impedance

more than 47 kΩ (kilohms))

Output impedance with less

than 2.2 kΩ (kilohms)/Stereo

minijack (ø 3.5 mm)

Input impedance more than

47 kΩ (kilohms)

DV input/output

4-pin connector

Headphone jack

Stereo minijack (ø 3.5 mm)

LANC jack

Stereo mini-minijack (ø 2.5 mm)

USB jack

mini-B

MIC jack

Minijack, 0.388 mV low

impedance with 2.5 to 3.0 V DC,

output impedance 6.8 kΩ

(kilohms) (ø 3.5 mm)

Stereo type

LCD screen

Picture

6.2 cm (2.5 type)

50 × 37 mm (2 × 1 1/2 in.)

Total dot number

211 200 (960 × 220)

Wireless communications

(DCR-PC120BT only)

Communications system

Bluetooth standard Ver.1.1

Max. baud rate¹⁾²⁾

Approx. 723 kbps

Output

Bluetooth standard Power Class

2

Communications distance²⁾

Max. wireless distance

Approx. 10 m (393 3/4 in.)

(When connecting to BTA-NW1)

Compatible Bluetooth profile³⁾

Generic Access Profile

Dial-up Networking Profile

Operating frequency band

2.4 GHz band (2.400 GHz – 2.483 5 GHz)

- 1) Max. baud rate of Bluetooth standard Ver.1.1
- 2) Varies according to the distance between communicating devices, presence of obstacles, radiowave conditions, and other factors.
- 3) This is a specification matched to specific usage requirements between Bluetooth compatible devices. It is laid down in the Bluetooth standards.

Specifications

General

Power requirements

7.2 V (battery pack)

8.4 V (AC power adaptor)

Average power consumption (when using the battery pack)

During camera recording using

LCD

4.4 W

Viewfinder

3.8 W

Operating temperature

0°C to 40°C (32°F to 104°F)

Storage temperature

-20°C to +60°C

(-4°F to +140°F)

Dimensions (Approx.)

57 × 118 × 113 mm

(2 1/4 × 4 3/4 × 4 1/2 in.)

(w/h/d)

Mass (approx.)

580 g (1 lb 4 oz)

main unit only

690 g (1 lb 8 oz)

including the battery pack

NP-FM50, cassette DVM60 and lens cap

Supplied accessories

See page 5.

AC power adaptor

Power requirements

100 – 240 V AC, 50/60 Hz

Power consumption

23 W

Output voltage

DC OUT: 8.4 V, 1.5 A in the operating mode

Operating temperature

0°C to 40°C (32°F to 104°F)

Storage temperature

-20°C to +60°C

(-4°F to +140°F)

Dimensions (approx.)

125 × 39 × 62 mm

(5 × 1 9/16 × 2 1/2 in.) (w/h/d)

excluding projecting parts

Mass (approx.)

280 g (9.8 oz)

excluding power cord

Battery pack

Maximum output voltage

DC 8.4 V

Output voltage

DC 7.2 V

Capacity

8.5 Wh (1 180 mAh)

Dimensions (approx.)

38.2 × 20.5 × 55.6 mm

(1 9/16 × 13/16 × 2 1/4 in.)

(w/h/d)

Mass (approx.)

76 g (2.7 oz)

Type

Lithium ion

“Memory Stick”

Memory

Flash memory

8MB: MSA-8A

Operating voltage

2.7 – 3.6 V

Power consumption

Approx. 45 mA in the operating mode

Approx. 130 µA in the standby mode

Dimensions (approx.)

50 × 2.8 × 21.5 mm

(2 × 1/8 × 7/8 in.) (w/h/d)

Mass (approx.)

4 g (0.14 oz)

Design and specifications are subject to change without notice.

Identifying the parts and controls

Camcorder

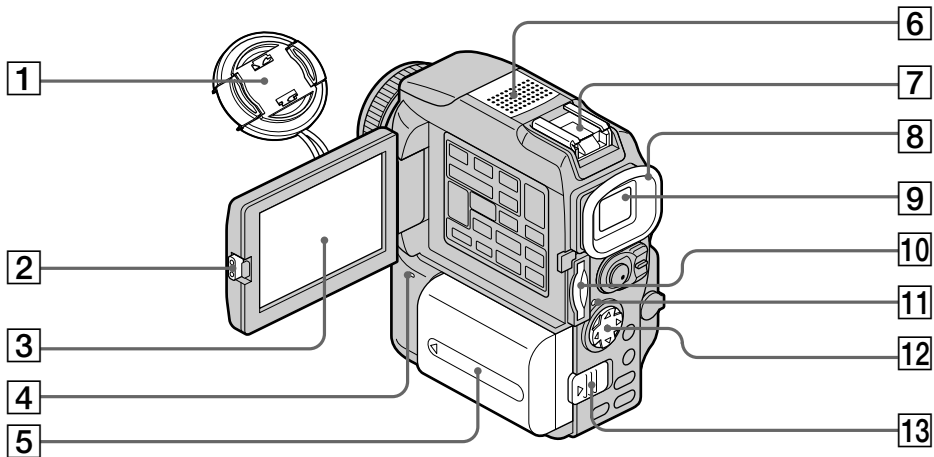

- | | |
|--|--------------------------------------|
| 1 Lens Cap (p. 20) | 6 Microphone |
| 2 OPEN button (p. 20) | 7 Intelligent accessory shoe (p. 86) |
| 3 LCD screen (p. 22) | 8 Eyecup |
| 4  (Bluetooth) lamp (DCR-PC120BT only) (p. 155) | 9 Viewfinder (p. 23) |
| 5 Battery pack/Battery terminal cover (p. 12) | 10 "Memory Stick" slot (p. 106) |
| | 11 Access lamp (p. 106) |
| | 12 Control button (p. 96) |
| | 13 BATT RELEASE lever (p. 12) |



This mark indicates that this product is a genuine accessory for Sony video products.

When purchasing Sony video products, Sony recommends that you purchase accessories with this "GENUINE VIDEO ACCESSORIES" mark.



Notes on the intelligent accessory shoe

- The intelligent accessory shoe supplies power to optional accessories such as a video light or microphone.
- The intelligent accessory shoe is linked to the POWER switch, allowing you to turn the power supplied by the shoe on and off. Refer to the operating instructions of the accessory for further information.
- The intelligent accessory shoe has a safety device for fixing the installed accessory securely. To connect an accessory, press down and push it to the end, and then tighten the screw.
- To remove an accessory, loosen the screw, and then press down and pull out the accessory.

Identifying the parts and controls

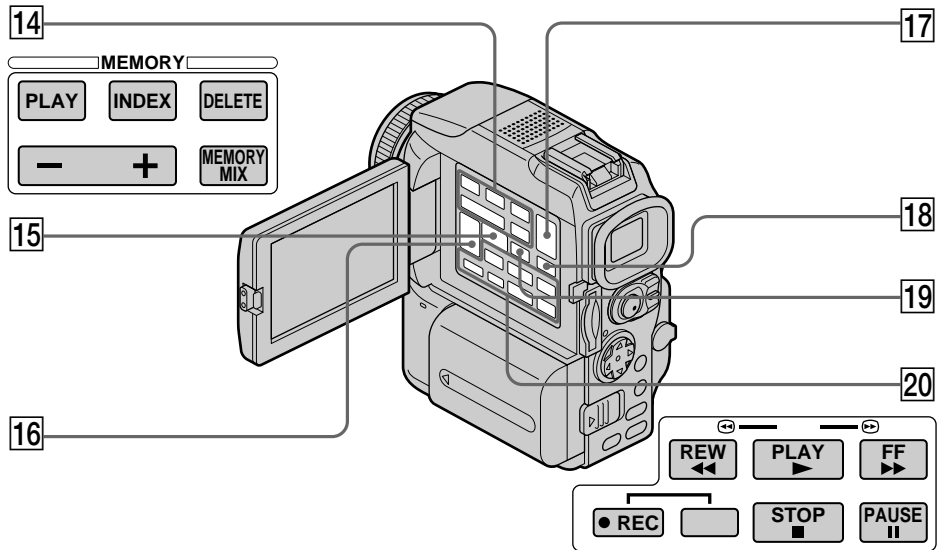

- 14** MEMORY operation buttons
 - MEMORY PLAY button (p. 136)
 - MEMORY INDEX button (p. 138)
 - MEMORY DELETE button (p. 151)
 - MEMORY +/- buttons (p. 136)
 - MEMORY MIX button (p. 121)
- 15** MPEG ►||/PB ZOOM button (p. 139/60, 148)
- 16** VOLUME buttons (p. 31)
- 17** EDITSEARCH button (p. 30)
- 18** DISPLAY button (p. 32)
- 19** END SEARCH button (p. 30)
- 20** Video control buttons (p. 33)
 - STOP (stop)
 - ◀◀ REW (rewind)
 - ▶▶ PLAY (playback)
 - ▶▶ FF (fastforward)
 - || PAUSE (pause)
 - REC (record)

Identifying the parts and controls

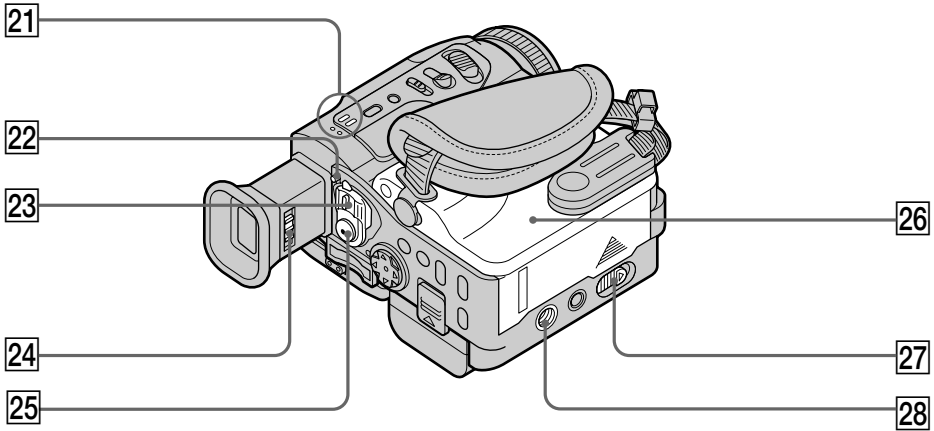

21 Speaker

22 LOCK switch (p. 20)

23 POWER switch (p. 20)

24 Viewfinder lens adjustment lever
(p. 23)

25 START/STOP button (p. 20)

26 Cassette lid (p. 19)

27 OPEN/▲ EJECT lever (p. 19)

28 Tripod receptacle

Make sure that the length of the tripod screw is less than 5.5 mm (7/32 inch). Otherwise, you cannot attach the tripod securely and the screw may damage your camcorder.

Identifying the parts and controls

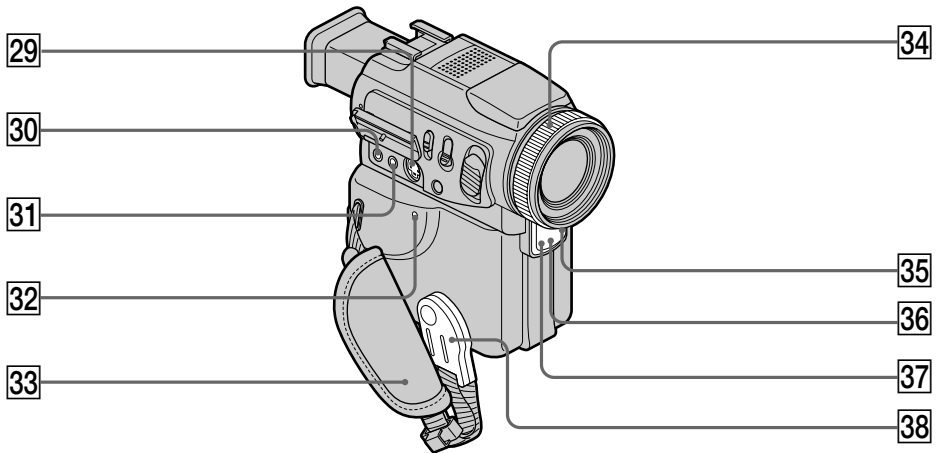

29 S VIDEO ID-2 jack (p. 35, 67, 80, 119)

30 MIC (PLUG IN POWER) jack
Connect an external microphone (optional). This jack also accepts a “plug-in-power” microphone.

31 AUDIO/VIDEO ID-2 jack
(p. 35, 67, 80, 119)

32 RESET button (p. 161)

33 Grip strap

34 Focus ring (p. 53)

35 Camera recording lamp (p. 20)

36 Infrared rays emitter (p. 27, 72)

37 Remote sensor

38 Holding Grip

Fastening the grip strap

Fasten the grip strap firmly.

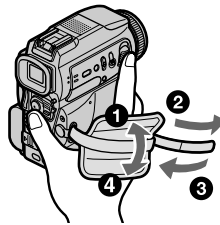

Identifying the parts and controls

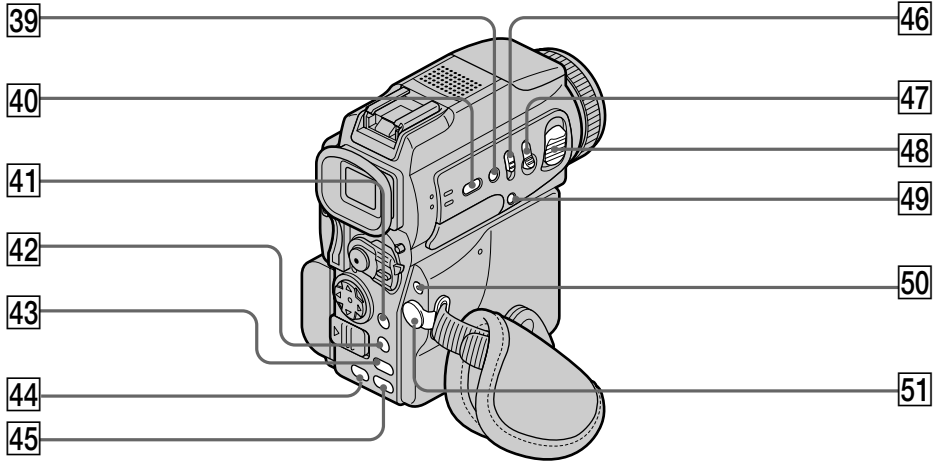

39 SUPER NIGHTSHOT button (p. 27)

40 FOCUS button (p. 53)

41 NETWORK button (p. 155)
(DCR-PC120BT only)

42 BROWSER MENU/MENU button
(p. 155/96) (DCR-PC120BT)/
MENU button (p. 96) (DCR-PC115)

43 EXPOSURE button (p. 52)

44 BACK LIGHT button (p. 27)

45 FADER button (p. 42)

46 NIGHTSHOT switch (p. 27)

47 PHOTO button (p. 36, 112)

48 Power zoom lever (p. 24, 60, 148)

49  (self-timer) button (p. 29, 39, 117)

50  (flash) button (p. 37, 115)

51  (headphones) jack
When you use headphones, the speaker
on your camcorder is silent.

Identifying the parts and controls

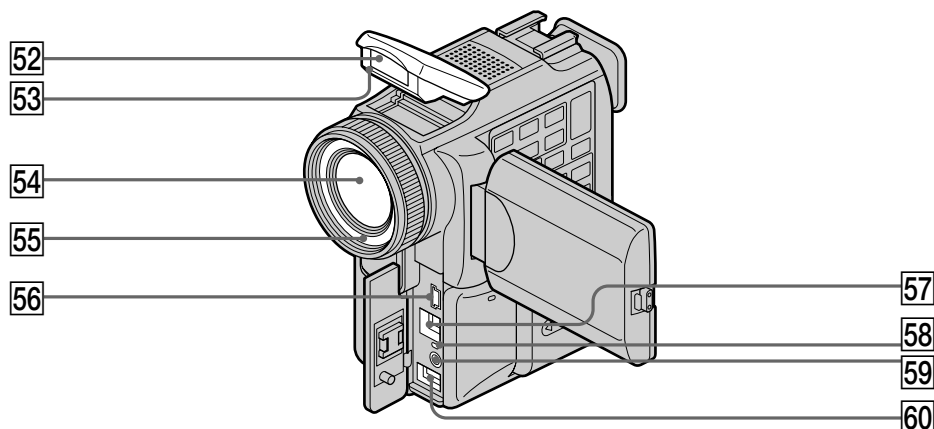

52 Flash (p. 37, 115)

53 HOLOGRAM AF emitter (p. 116)

54 Lens

55 Photocell window for flash
Do not block this window when recording.

56 Ψ (USB) jack (p. 142)

57 \mathbb{I} DV jack (p. 68, 80, 120)

58 CHG (charge) lamp (p. 13)

59 \blacktriangleleft LANC jack

60 DC IN jack (p. 15)

Note on the Carl Zeiss lens

Your camcorder is equipped with a Carl Zeiss lens which can reproduce a fine image.

The lens for your camcorder was developed jointly by Carl Zeiss, in Germany, and Sony Corporation. It adopts the MTF[#] measurement system for video camera and offers a quality as the Carl Zeiss lens.

The lens for your camcorder is also T*-coated to suppress unwanted reflection and faithfully reproduce colors.

[#] MTF is an abbreviation of Modulation Transfer Function.

The value number indicates the amount of light of a subject penetrating into the lens.

Identifying the parts and controls

Remote Commander

The buttons that have the same name on the Remote Commander as on your camcorder function identically to the buttons on your camcorder.

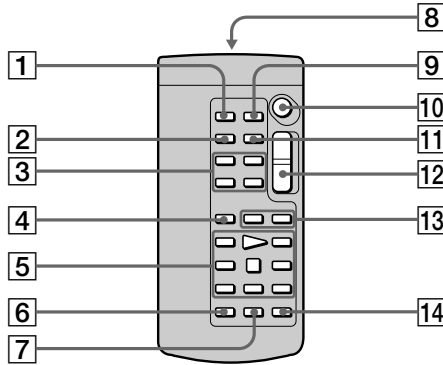

- | | |
|---|---|
| 1 PHOTO button (p. 36, 112) | 8 Transmitter
Point toward the remote sensor to control your camcorder after turning on your camcorder. |
| 2 DISPLAY button (p. 32) | 9 ZERO SET MEMORY button (p. 61) |
| 3 Memory control buttons (p. 136) | 10 START/STOP button (p. 20) |
| 4 SEARCH MODE button (p. 62, 63, 65) | 11 DATA CODE button (p. 32) |
| 5 Video control buttons (p. 33) | 12 Power zoom button (p. 24) |
| 6 REC button (p. 81, 83, 85) | 13 ◀▶ buttons (p. 62, 63, 65) |
| 7 MARK button (p. 77, 132) | 14 AUDIO DUB button (p. 88) |

To prepare the Remote Commander

Insert two size AA (R6) batteries by matching the + and - polarities on the batteries to the + - marks inside the battery compartment.

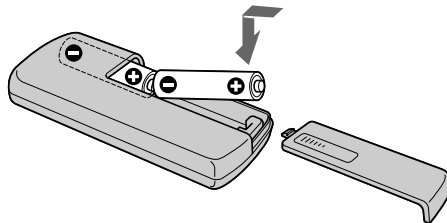

Notes on the Remote Commander

- Point the remote sensor away from strong light sources such as direct sunlight or overhead lighting. Otherwise, the Remote Commander may not function properly.
- Your camcorder works in the commander mode VTR 2. Commander modes 1, 2 and 3 are used to distinguish your camcorder from other Sony VCRs to avoid remote control misoperation. If you use another Sony VCR in the commander mode VTR 2, we recommend changing the commander mode or covering the sensor of the VCR with black paper.

Operation indicators

LCD screen and Viewfinder

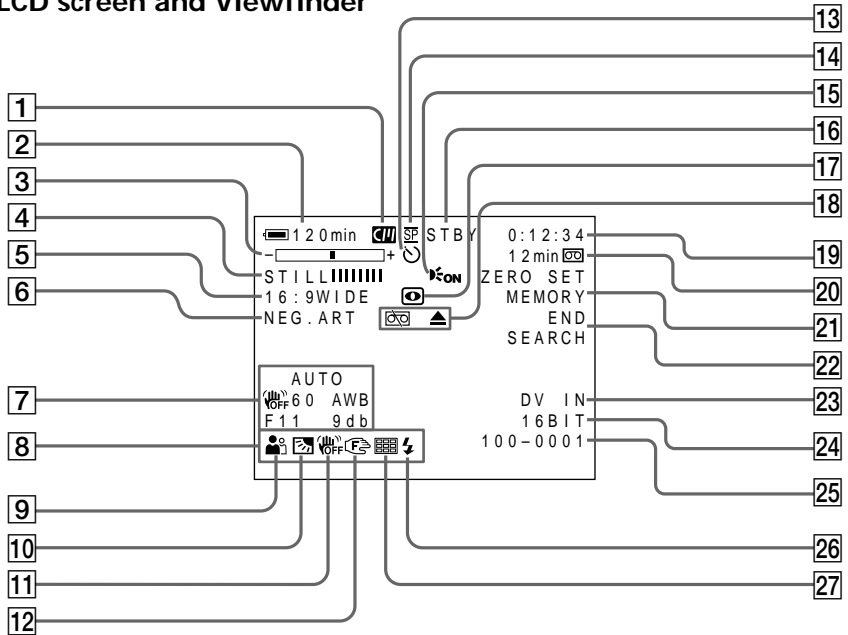

- 1 Cassette memory (p. 26, 165)
- 2 Remaining battery time (p. 26)
- 3 Zoom (p. 24)/Exposure (p. 52)/
Data file name (p. 104)
- 4 Digital effect (p. 46, 59)/MEMORY MIX
(p. 121)/FADER (p. 42)
- 5 16:9WIDE (p. 41)
- 6 Picture effect (p. 45, 58)
- 7 Data code (p. 32)
- 8 Volume (p. 31)/Date (p. 26)
- 9 PROGRAM AE (p. 49)
- 10 Backlight (p. 27)
- 11 SteadyShot off (p. 97)
- 12 Manual focus/Infinity (p. 53)
- 13 Self-timer (p. 29, 39, 117)
- 14 Recording mode (p. 26)
- 15 HOLOGRAM AF (p. 116)
- 16 STBY/REC (p. 20)/Video control mode
(p. 33)/Image size (p. 109)/Image
quality mode (p. 107)
- 17 NIGHTSHOT (p. 27)/SUPER NIGHTSHOT
(p. 28)
- 18 Warning (p. 163)
- 19 Tape counter (p. 26)/Time code (p. 26)/
Self-diagnosis (p. 162)/Tape photo
(p. 36)/Memory photo (p. 112)/
Image number (p. 137, 140)
- 20 Remaining tape (p. 26)/Memory
playback (p. 137)
- 21 ZERO SET MEMORY (p. 61)
- 22 END SEARCH (p. 30)
- 23 A/V → DV (p. 80)/DV IN (p. 83)
- 24 Audio mode (p. 102)
- 25 Data file name (p. 121)/Time (p. 26)
- 26 Flash (p. 37, 115)
This indicator appears only when the
flash is in use.
- 27 Continuous mode (p. 113)

Index

A, B

AC power adaptor	13
Adjusting viewfinder	23
Audio dubbing	86
AUDIO MIX	98
Audio mode	102
Auto red-eye reduction ..	37, 115
AUTO SHTR	97
A/V connecting cable	
..... 35, 67, 80, 81, 119, 130	
BACK LIGHT	27
Battery pack	12
BEEP	103
BOUNCE	42

C, D

Camera chromakey	121
Cassette memory	10, 165
Charging battery	13
Charging built-in rechargeable	
battery	174
Clock set	16
Continuous	113
Control button	96
Cut recording	57
Data code	32
Date search	63
DEMO	102
DIGITAL EFFECT	46, 59
Digital program editing	
..... 69, 132	
DISPLAY	32
DOT	42
Dual sound track tape	166
DV connecting cable	
..... 68, 80, 120	

E

EDITSEARCH	30
END SEARCH	30, 34
Exposure	52

F, G, H

FADER	42
Fade in/out	42
Flash	37, 115
FLASH MOTION	46
FOCUS	53
Format	100, 104
Full charge	13
Grip strap	182
Ⓜ (Headphone) jack	183
Heads	173
HiFi SOUND	98
HIGH SPEED	113
Holding Grip	8
HOLOGRAM AF	116

I, J, K, L

iLINK	169
Image protection	150
Image quality mode	107
Image size	109
Index screen	138
"InfoLITHIUM" battery	167
Infrared rays emitter	27, 72
Insert editing	84
Intelligent accessory shoe	179
Interval recording	55
JPEG	104
Labeling a cassette	94
LANC jack	184
LUMINANCEKEY	46

M, N

Main sound	166
Manual focus	53
Memory chromakey	121
Memory luminancekey	121
MEMORY MIX	121
Memory PB ZOOM	148
Memory photo recording	112
"Memory Stick"	104
Menu settings	96
Memory overlap	121
M-FADER	42
Mirror mode	25
Moisture condensation	172
MONOTONE	42
MPEG	104
MPEG movie recording	126
MULTI SCRN	113
NETWORK	155
NIGHTSHOT	27
NTSC system	171

O, P, Q

OLD MOVIE	46
Operation indicators	186
OVERLAP	42
Photo save	135
Photo scan	65
Photo search	65
PICTURE EFFECT	45, 58
Picture search	33
Playback pause	33
Playing time	14
Power zoom	24
Print mark	153
PROGRAM AE	49

R

Recording time	14
Rec Review	30
Remaining battery time	
indicator	26
Remaining tape indicator	26
Remote Commander	185
Remote sensor	182
RESET	161

S

Self-diagnosis display	162
Self-timer recording	
..... 29, 39, 117	
Signal convert function	80
Skip scan	33
Slide show	149
Slow playback	33
SLOW SHUTTER	46
STEADYSHOT	97
Stereo tape	166
STILL	46
Sub sound	166
SUPER NIGHTSHOT	27
S VIDEO jack	
..... 35, 67, 80, 81, 119, 130	

T, U, V

Tape counter	26
Tape PB ZOOM	60
Tape photo recording	36
Telephoto	24
Time code	26
Title	90, 93
Title search	62
TRAIL	46
Transition	21
TV color systems	171
USB jack	142

W, X, Y, Z

Warning indicators	163
White balance	40
Wide-angle	24
Wide mode	41
WIPE	42
Write-protect tab	19, 104
Zero set memory	61
Zoom	24

<http://www.world.sony.com/>

Printed on recycled paper

Sony Corporation Printed in Japan

